



The complete range of  
**TECE** drainline shower channels

**TECE:**  
Intelligent housing technology



# TECEdrainline shower channels

TECEdrainline shower channels clear the bathroom of any items that get in the way, such as shower tubs and cubicles, and make it possible to uniformly design the floor. This gives rise to barrier-free bathrooms of generous proportions – real rooms for living in, in fact. TECEdrainline shower channels come either with stainless steel/glass covers or with the “plate” tileable channel where a plain slot in the floor is the only thing that can be seen.





TECEdrainline – now also available with glass cover.

With the new shower channel covers made of glass and brushed stainless steel, TECE opts for high-class materials in the bathroom.

The glass cover colour matches the glass covers of the TECEloop and TECESquare push plates. Available in the three colours white, mint green and black.





Still tough despite the transparent look: The safety glass sits on a particularly robust stainless steel support.

# TECEdrainline glass

## TECEdrainline glass

- straight lengths 700, 800, 900, 1000, 1200, 1500 mm (total channel length)
- visible width of 73 mm
- withstands a 300 kg load

The article numbers for your order and the required accessories can be found on pages 22 ff. of this brochure.



Glass white



Glass green



Glass black

Like the “plate” tileable channel, the glass cover forms an enclosed surface that can be inserted into the bathroom floor. The shower water flows off easily through a narrow drainage opening around the channel.

TECE provides the glass cover in standard colours mint green, black and white. The round-edged safety glass is permanently fixed to the underlying robust stainless steel support by means of a special adhesive.

Our most attractive shower channel  
is practically invisible.

Thanks to the “plate” tileable channel, the shower channel can be perfectly fitted into the flooring. The “plate” is particularly ideal with natural stone floors. The sound construction of the TECEdrainline channel permits particularly narrow drainage slots. The tileable channel can also be provided for the angled channel in various dimensions (see page 22 ff.).



# TECEdrainline “plate”



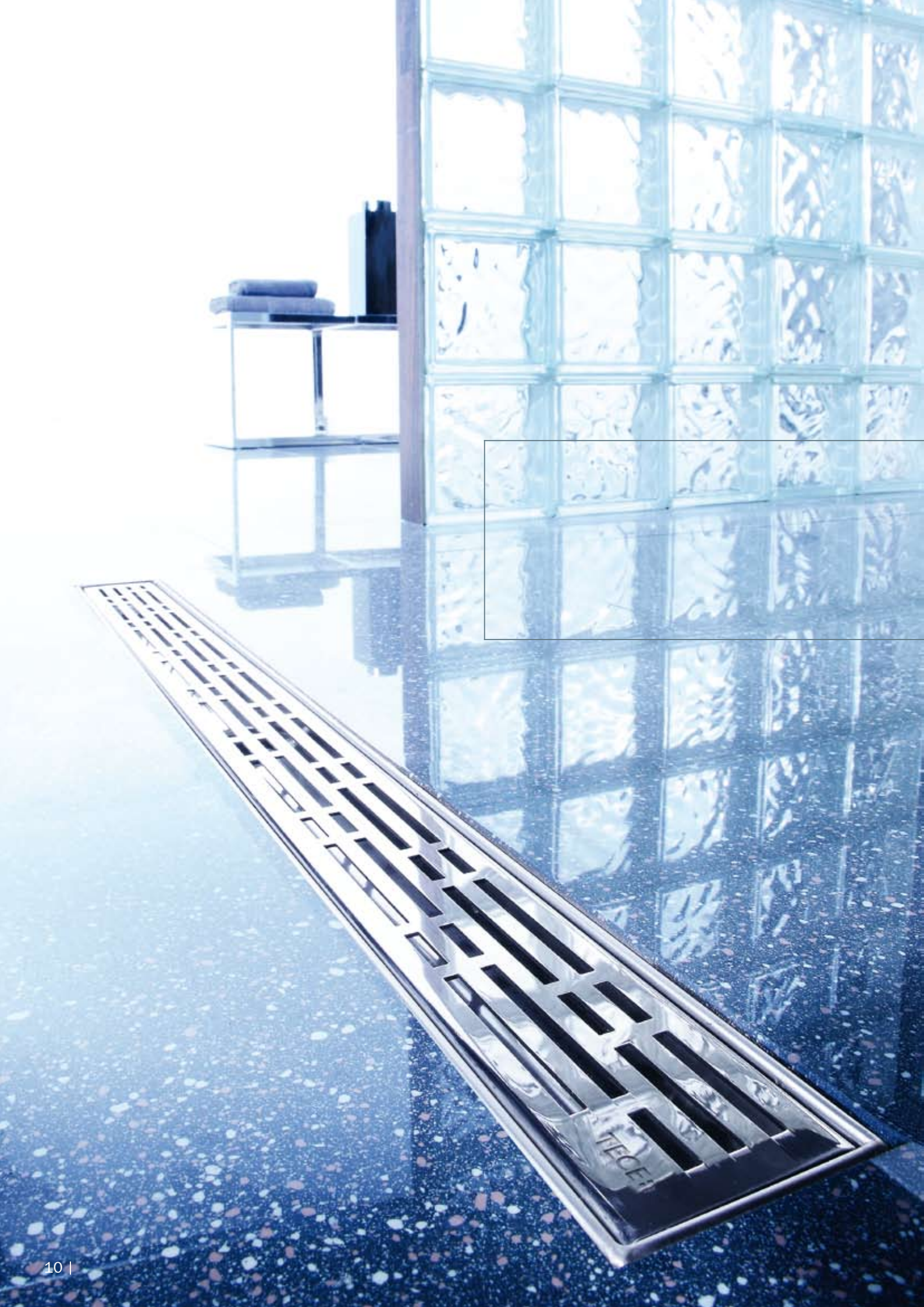

# TECEdrainline stainless steel grates

Set fresh nuances – with  
TECEdrainline stainless steel grates.

Stainless steel is a material which is typically used in the bathroom: authentic, permanent and conveying a sense of value. The stainless steel grates are available in a variety of designs – and either brightly polished or mat brushed.



Design "basic"



Design "lines"

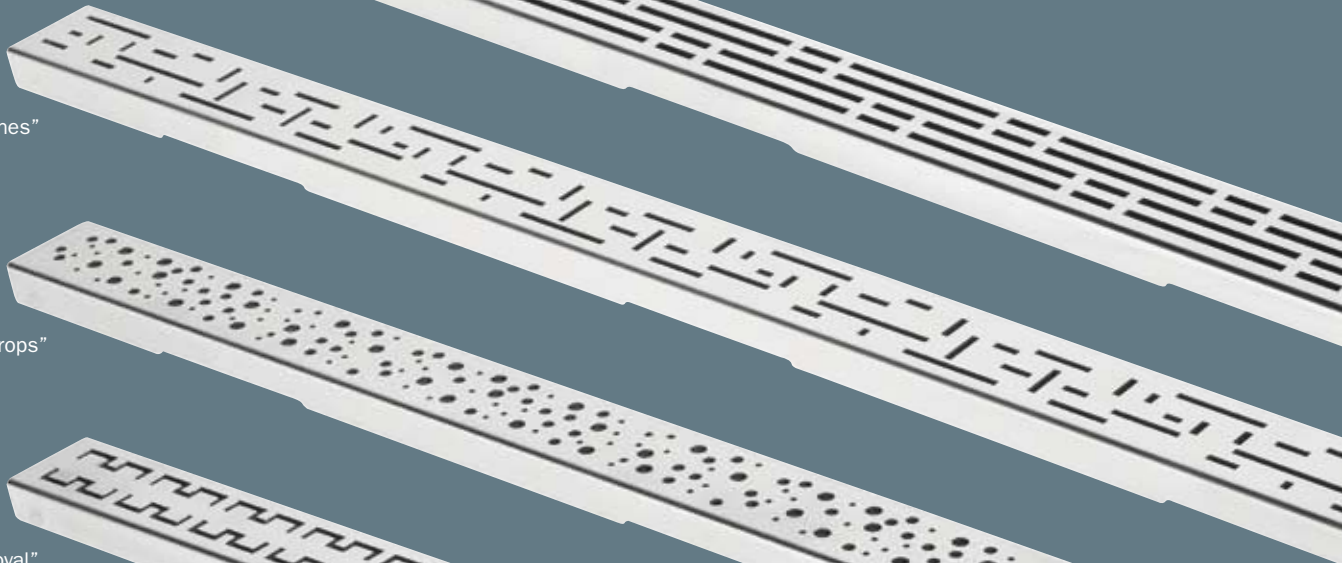

Design "drops"

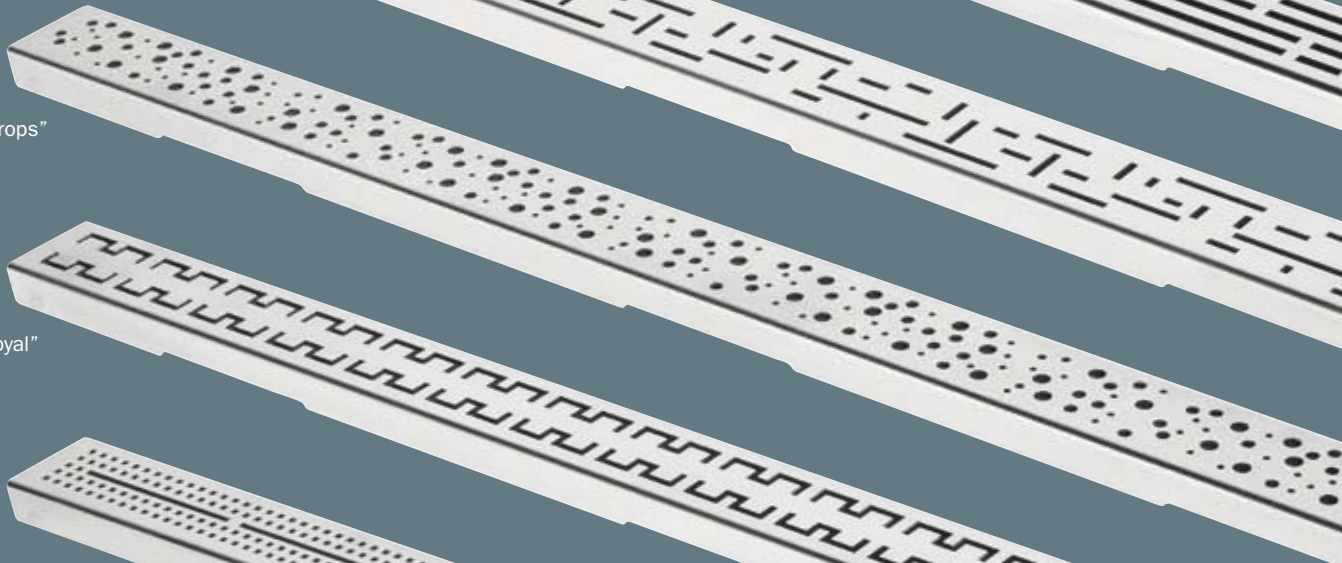

Design "royal"

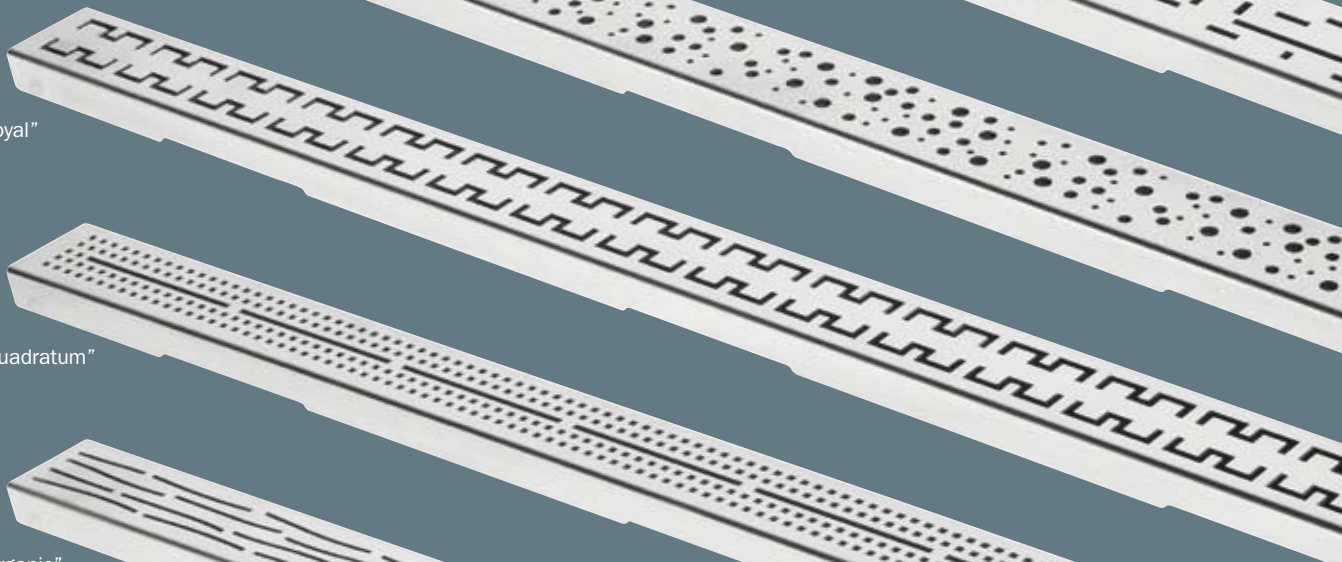

Design "quadratum"

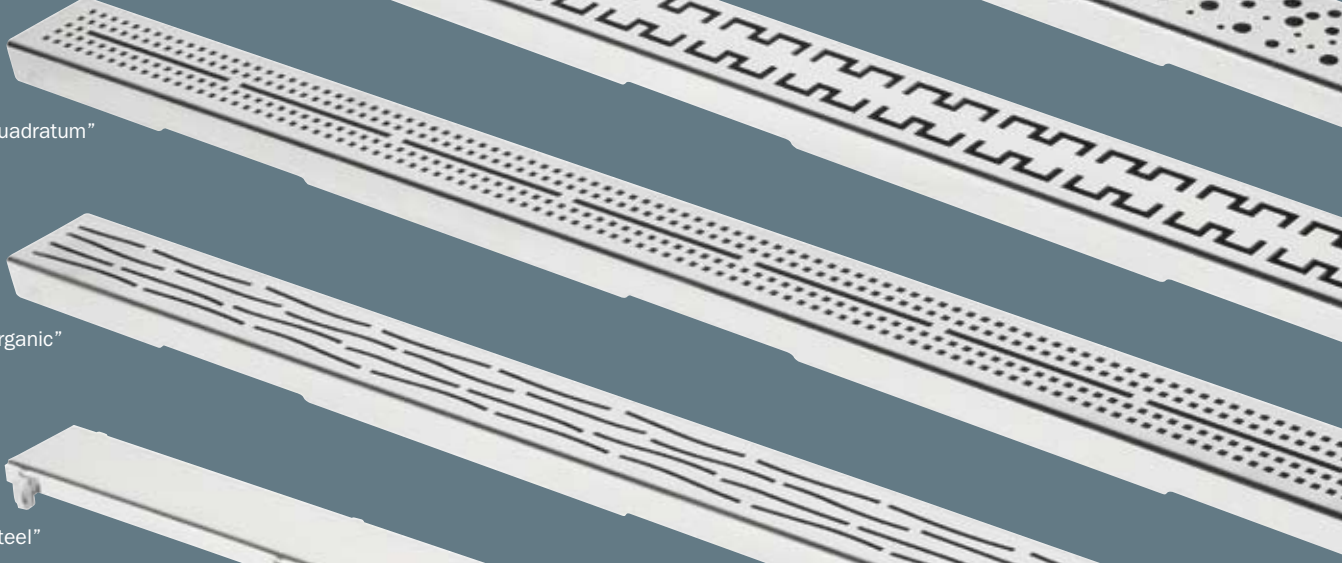

Design "organic"

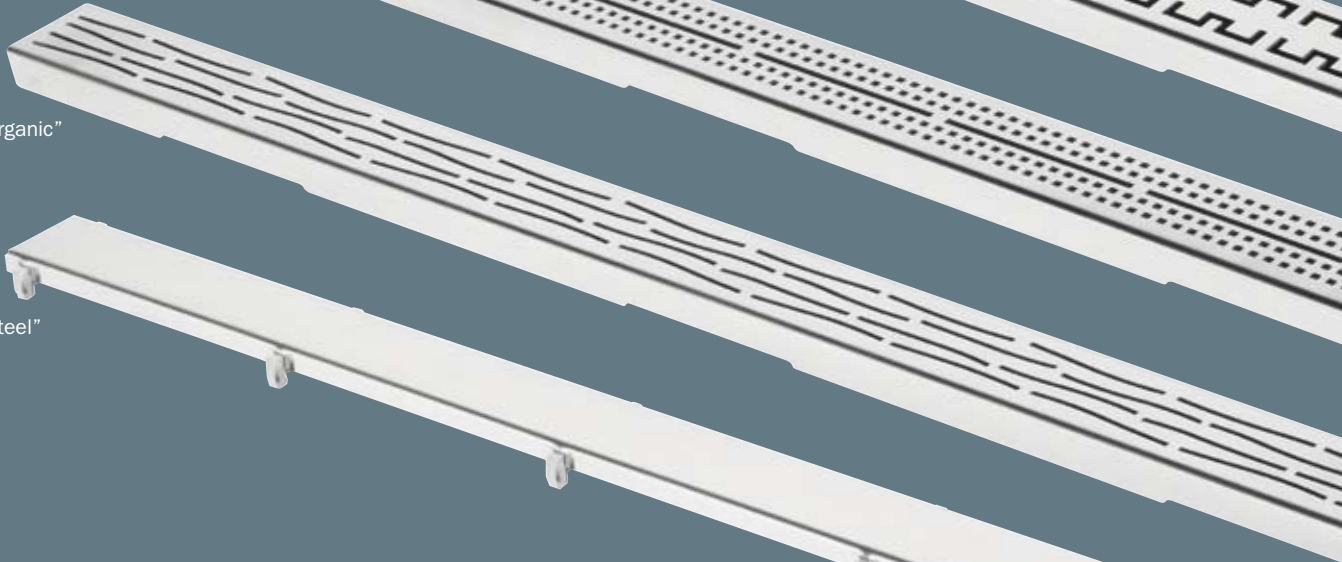

Design "steel"

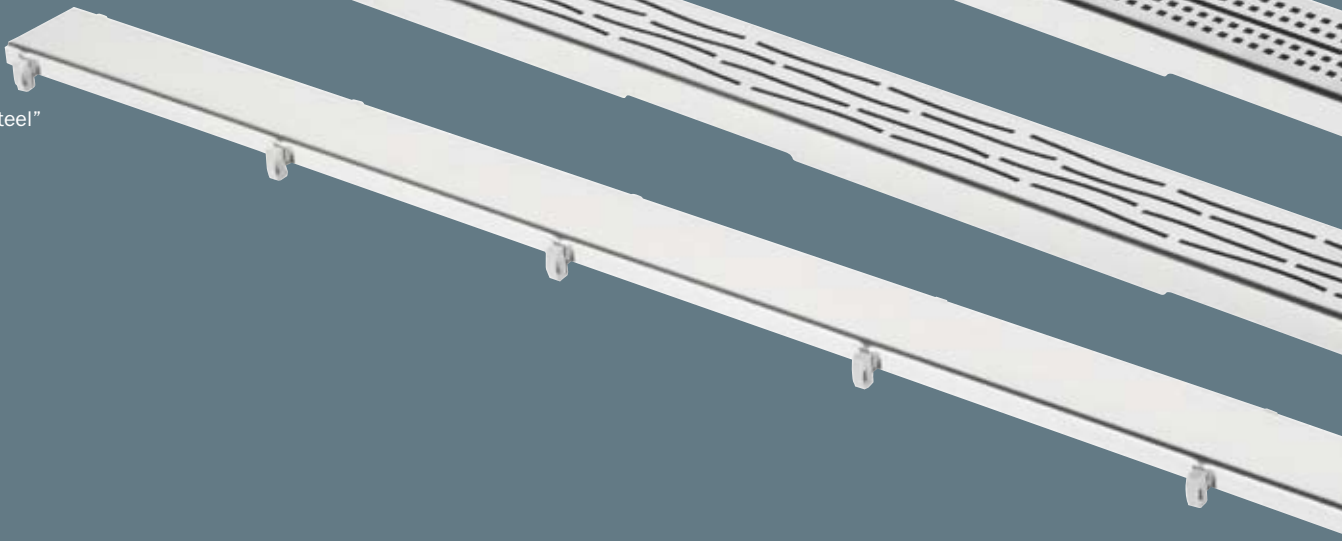

# TECEdrainline stainless steel grates

- straight lengths 700, 800, 900, 1000, 1200, 1500 mm (total channel length)
- visible width of 73 mm
- custom lengths from 400 up to a max. 1500 mm are also available at short notice
- stainless steel surface either polished or brushed
- all designs can also be provided as angled channels

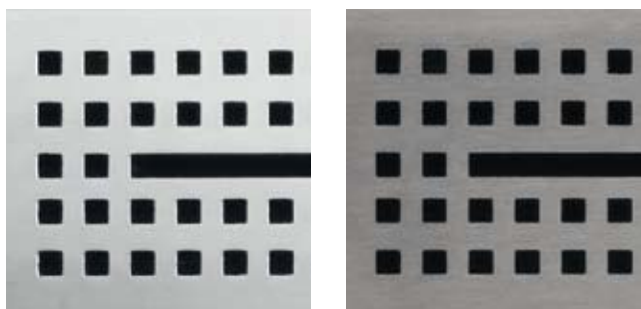
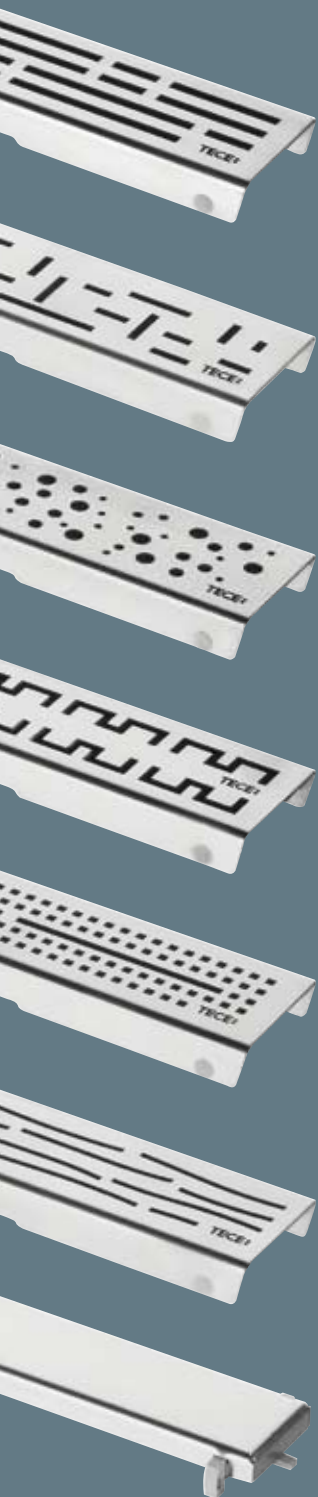

All the grates are available in stainless steel and either polished or brushed.

The article numbers for your order and the required accessories can be found on pages 22 ff. of this brochure.



# TECEdrainline angled channels

Reveal a clear-cut contour – with  
TECEdrainline angled channels.

## **Stainless steel angled channels**

Unique – the TECEdrainline angled channel range: Choose between 7 different design variants with stainless steel surfaces either brightly polished or mat brushed. The angled channel can also be obtained as a “plate” tileable channel. The grates can be provided up to a 1500 mm side length.

# TECEdrainline – new feeling of freedom in bathroom design.



TECEdrainline shower channels open up new design options in bathroom architecture – and bathroom planners take advantage of this new freedom. Thus stainless steel channels can not only be fitted between the dry and wet areas but also, for instance, directly at the wall.

Close wall installation of the TECEdrainline in the “steel” grate design: A mere 1% gradient to the wall suffices for directing the water into the shower channel.



Standard installation of TECEdrainline in the entry to the shower as a wet-to-dry area transition featuring the “quadratum” grate design.



# TECEdrainline mounting variants

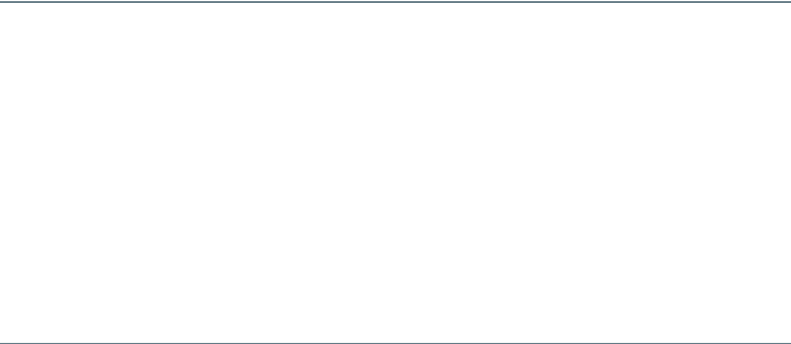

Another option is the use of an angled channel or the “plate” tileable channel, which can be clad with the respective flooring.

Installation with angled channel and “drops” grate design.



Fitting two parallel “plate” tileable channels.

### Installation and sealing

The channel body is kept stable through complete underfilling with screed. The channel is sealed with the thin-bed seal and special sealing fleece combined with the tile cover. A completely tight connection between the flange and fleece is achieved through the adhesive tape applied to the flange in the factory. The additional installation of the Drainbase sound insulation mat ensures effective sound insulation.

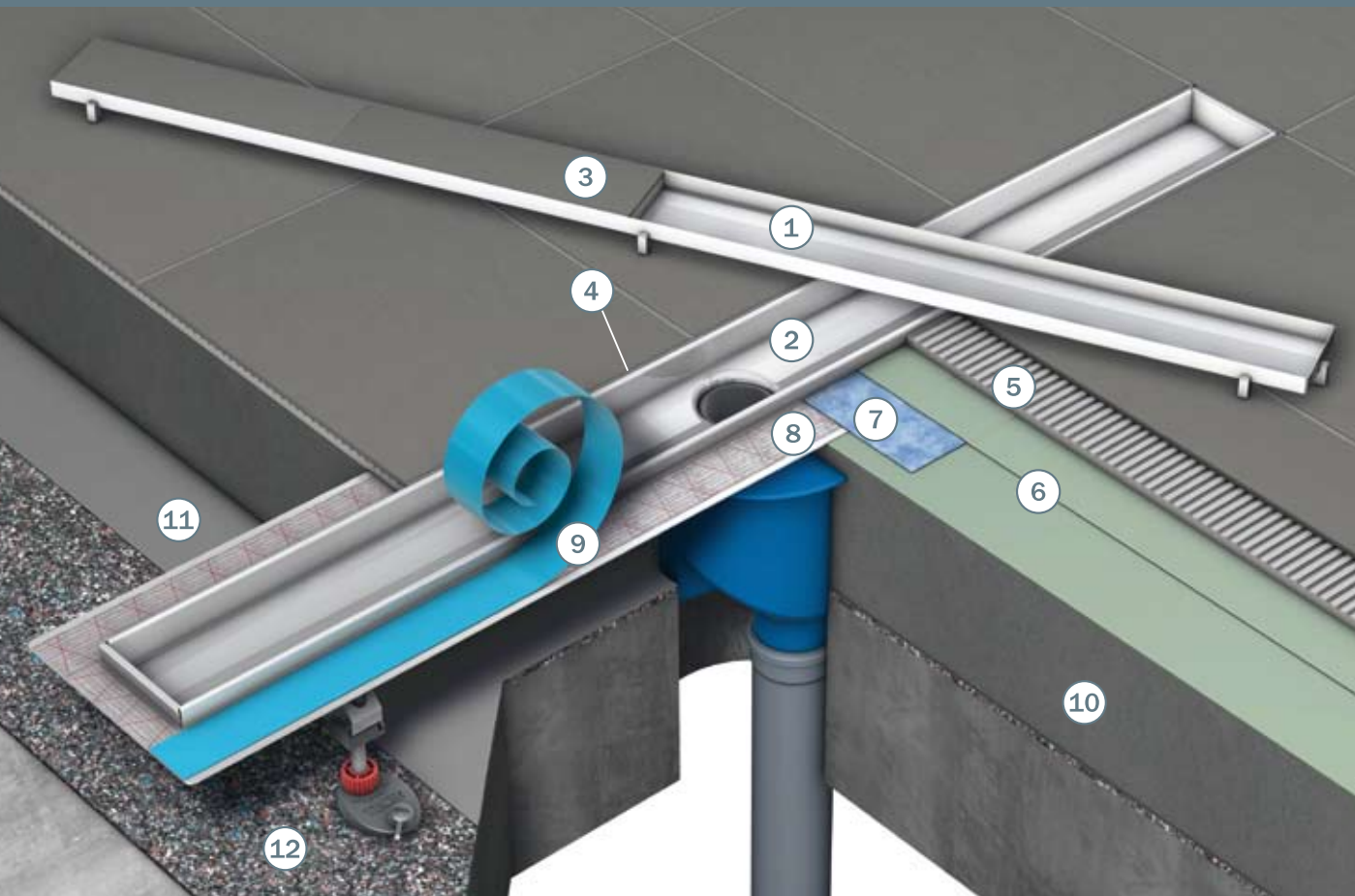

- |                             |                                      |
|-----------------------------|--------------------------------------|
| 1. "plate" tileable channel | 8. Channel flange with adhesive tape |
| 2. Channel body             | 9. Removable protective film         |
| 3. Tile cover               | 10. Screed                           |
| 4. Elastic grouting         | 11. PE foil                          |
| 5. Tile adhesive            | 12. Drainbase sound insulation mat   |
| 6. Insulating paint         |                                      |
| 7. Seal sleeve              |                                      |

# TECEdrainline details and extras

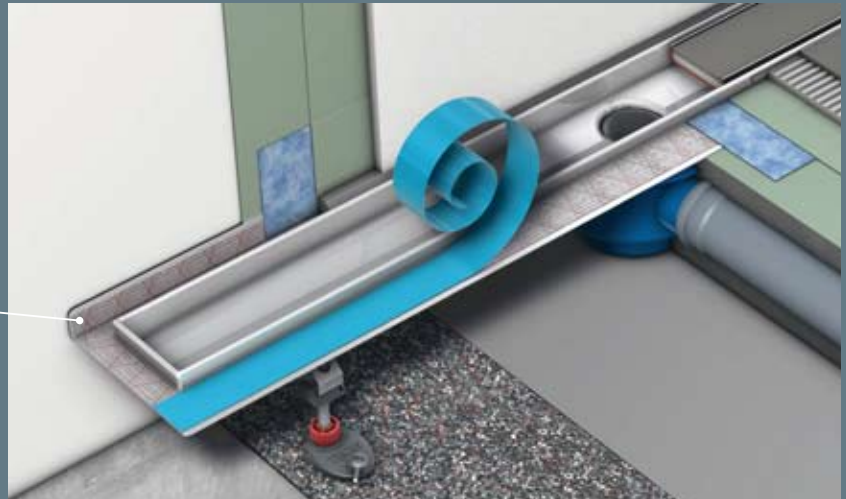

## Installation close to the wall

The flange of every channel is pre-punched along one side and the customer can therefore bend it easily. For this reason, the channel can be installed even closer to the wall. A narrow joint only remains as a space.

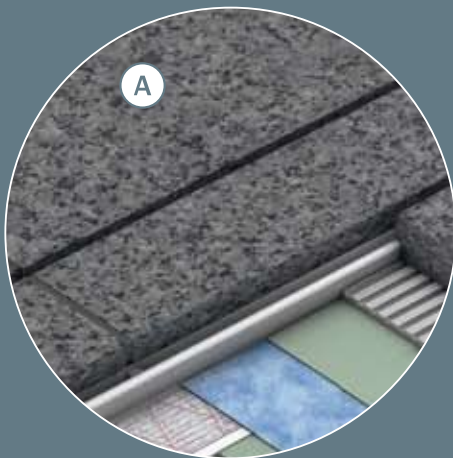

## TECEdrainline in natural stone floors

In view of its sound construction, the TECEdrainline channel is especially suited for installation in natural stone floors. A suitably counter-sunk natural stone insert (A) serves as the cover. All that remain are two almost invisible gaps in the otherwise uniform stone flooring.

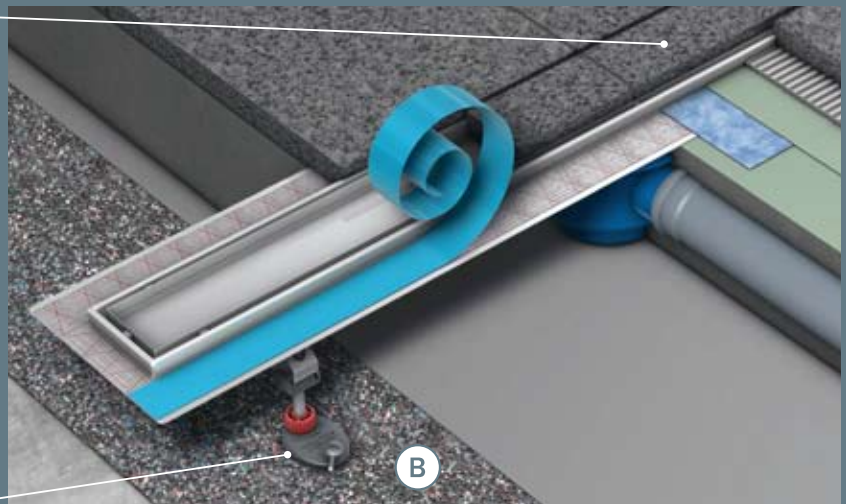

## Perfect sound insulation

(B) Effective sound insulation in the shower comes from the TECEdrainbase mat. Its low compression rules out any subsequent lowering of the screed.



(C) A protective cap on the screw stops any acoustic bridging forming between screed and bare floor.

# TECEdrainline installation and sealing

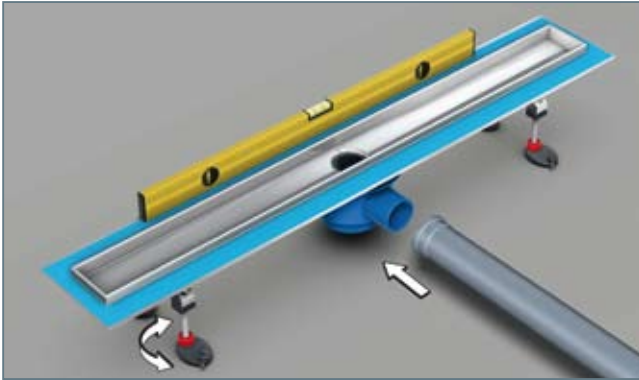

Setting of the channel height using the adjustable bases, checking done with the spirit level. Connection of the rotatable drain using a DN 50 or DN 70 drain pipe.

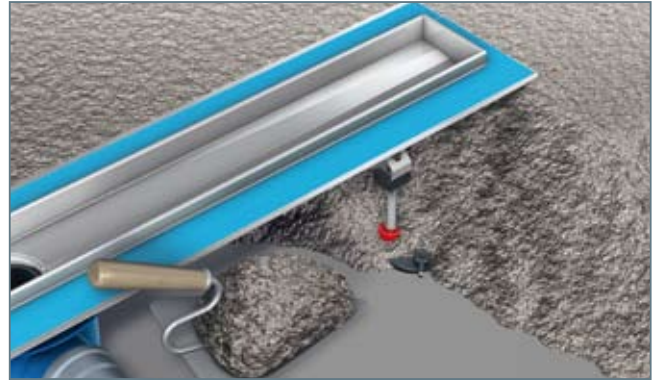

Installation of the shower channel: The channel body and drain are anchored stably through complete underfilling with screed.

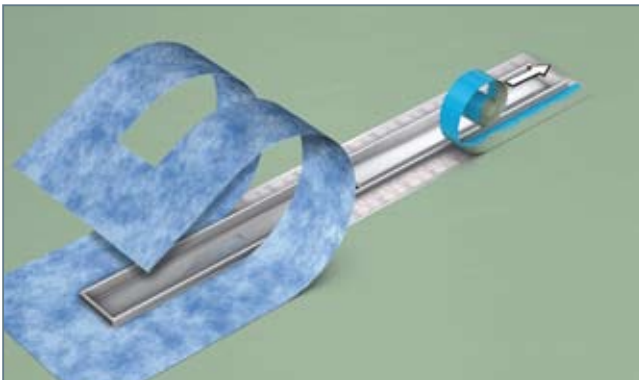

The sealing fleece is fitted once the protective film is removed. The adhesive applied to the flange in the factory ensures a completely tight connection between the flange and fleece.

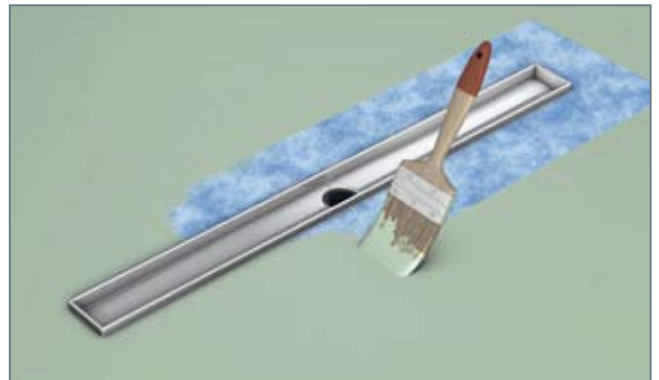

The final step before tiling is the application of the insulation paint.

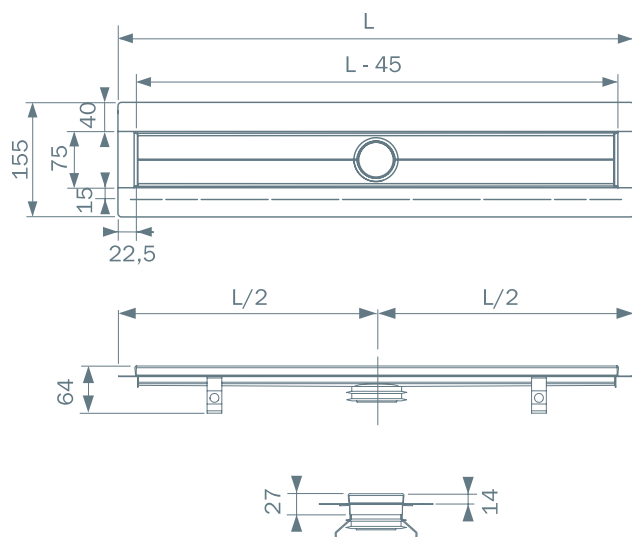

The length of the channel body is tailored to the standard dimensions of TECEdrainline grates.

- Lengths for straight channels from 700 to 1500 mm (visible dimension after assembly L-45 mm)
- L lengths for angled channels from 900 x 900 to 1500 x 1500 mm (visible dimension after assembly L-22.5 mm)
- Option of installation close to the wall



# TECEdrainline drains

The range includes four drains for different requirements and structural features. The models match all the shower channels in the TECEdrainline range.

- DN 50 drain with particularly low installation height of 95 mm with a 0.7 l/s drainage capacity, ideal for the refurbishment of older buildings
- DN 70 drain with particularly high drainage capacity of 1.2 l/s with standard-compliant sealing water height in accordance with DIN EN 1253, ideal for power showers
- Vertical drain for floor bushing

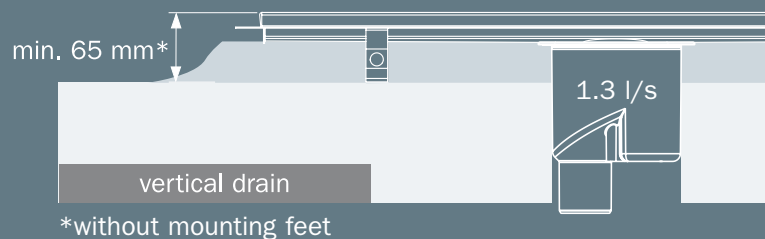
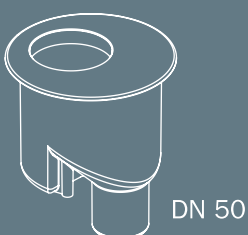
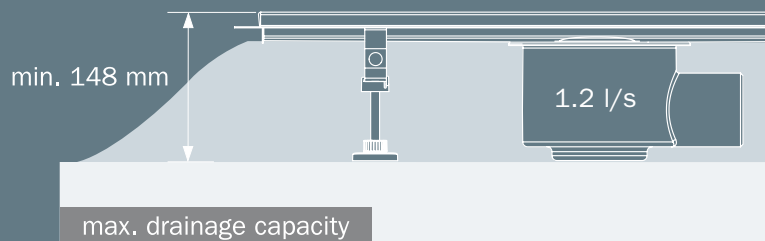
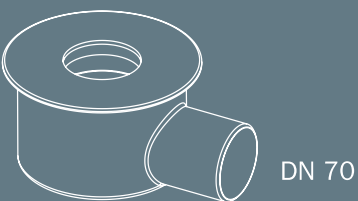
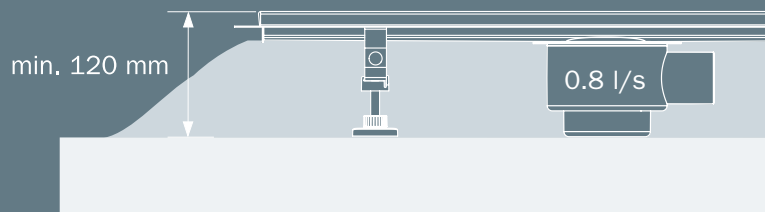
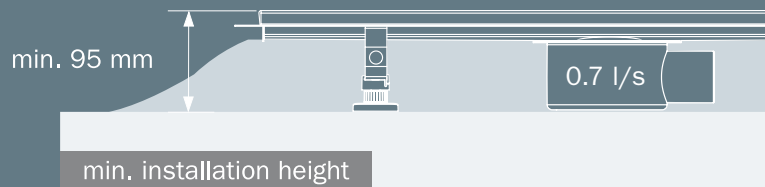

# How to order:

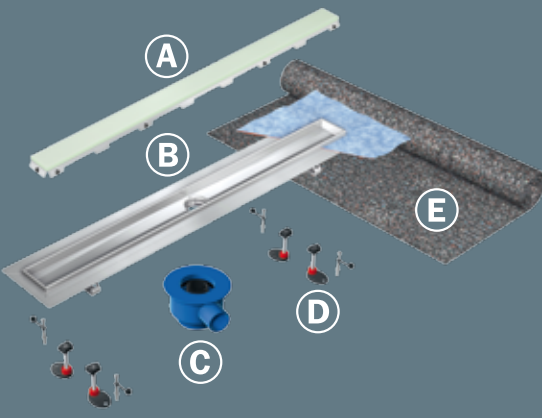

**A straight TECEdrainline shower channel always consists of:**

- (A) a design grate or a “plate” tile channel or a glass cover
- (B) a channel
- (C) a drain

Accessories (optional)

- (D) assembly feet (1 set)
- (E) Drainbase sound insulating mat

# A

## Straight grates, polished or brushed stainless steel, tile channel, glass covers

Channel length		700 mm	800 mm	900 mm
Grate, channel, glass cover	Surface	Order No.	Order No.	Order No.
"basic"	polished	6 007 10	6 008 10	6 009 10
	brushed	6 007 11	6 008 11	6 009 11
"lines"	polished	6 007 20	6 008 20	6 009 20
	brushed	6 007 21	6 008 21	6 009 21
"drops"	polished	6 007 30	6 008 30	6 009 30
	brushed	6 007 31	6 008 31	6 009 31
"royal"	polished	6 007 40	6 008 40	6 009 40
	brushed	6 007 41	6 008 41	6 009 41
"quadratum"	polished	6 007 50	6 008 50	6 009 50
	brushed	6 007 51	6 008 51	6 009 51
"organic"	polished	6 007 60	6 008 60	6 009 60
	brushed	6 007 61	6 008 61	6 009 61
"steel"	polished	6 007 80	6 008 80	6 009 80
	brushed	6 007 81	6 008 81	6 009 81
"plate"	polished	6 007 70	6 008 70	6 009 70
Glass green	Glass	6 007 90	6 008 90	6 009 90
Glass white	Glass	6 007 91	6 008 91	6 009 91
Glass black	Glass	6 007 92	6 008 92	6 009 92

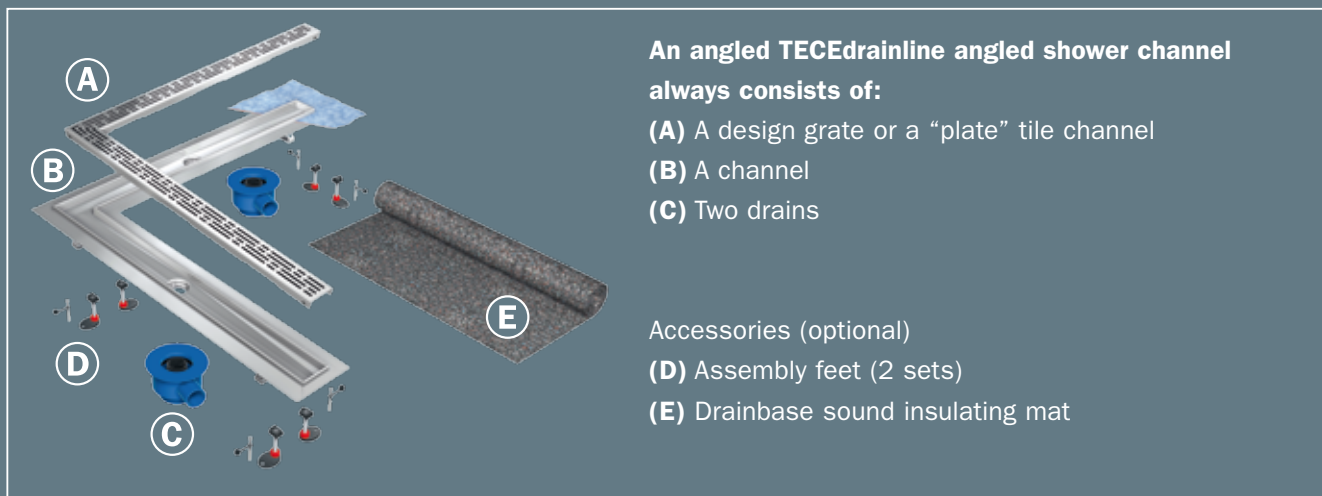

**An angled TECEdrainline angled shower channel always consists of:**

- (A)** A design grate or a “plate” tile channel
- (B)** A channel
- (C)** Two drains

Accessories (optional)

- (D)** Assembly feet (2 sets)
- (E)** Drainbase sound insulating mat

**Angled grates 90°, polished or brushed stainless steel, tile channel**

1,000 mm	1,200 mm	1,500 mm
Order No.	Order No.	Order No.
6 010 10	6 012 10	6 015 10
6 010 11	6 012 11	6 015 11
6 010 20	6 012 20	6 015 20
6 010 21	6 012 21	6 015 21
6 010 30	6 012 30	6 015 30
6 010 31	6 012 31	6 015 31
6 010 40	6 012 40	6 015 40
6 010 41	6 012 41	6 015 41
6 010 50	6 012 50	6 015 50
6 010 51	6 012 51	6 015 51
6 010 60	6 012 60	6 015 60
6 010 61	6 012 61	6 015 61
6 010 80	6 012 80	6 015 80
6 010 81	6 012 81	6 015 81
6 010 70	6 012 70	6 015 70
6 010 90	6 012 90	6 015 90
6 010 91	6 012 91	6 015 91
6 010 92	6 012 92	6 015 92

900/900 mm	1,000/1,000 mm	1,200/1,200 mm	1,500/1,500 mm
Order No.	Order No.	Order No.	Order No.
6 109 10	6 110 10	6 112 10	6 115 10
6 109 11	6 110 11	6 112 11	6 115 11
6 109 20	6 110 20	6 112 20	6 115 20
6 109 21	6 110 21	6 112 21	6 115 21
6 109 30	6 110 30	6 112 30	6 115 30
6 109 31	6 110 31	6 112 31	6 115 31
6 109 40	6 110 40	6 112 40	6 115 40
6 109 41	6 110 41	6 112 41	6 115 41
6 109 50	6 110 50	6 112 50	6 115 50
6 109 51	6 110 51	6 112 51	6 115 51
6 109 60	6 110 60	6 112 60	6 115 60
6 109 61	6 110 61	6 112 61	6 115 61
6 109 80	6 110 80	6 112 80	6 115 80
–	–	–	–
6 109 70	6 110 70	6 112 70	6 115 70

**Custom lengths and exclusive designs**

We will be happy to produce custom lengths up to 1500 mm or a grate design to suit your own specifications. We will advise you of the costs when you submit your enquiry. Delivery time: 4–6 weeks from approval and clarification of all details. Custom lengths and custom finishes cannot be cancelled after approval is given and may not be returned. Maximum length to order: 1,500 mm.

# B





## Channels incl. sealing fleece

Channel length	700 mm	800 mm	900 mm	1,000 mm	1,200 mm	1,500 mm
Visible dimensions following assembly	655 mm	755 mm	855 mm	955 mm	1,155 mm	1,455 mm
	Order No.	Order No.	Order No.	Order No.	Order No.	Order No.
Straight channels 	6 007 00	6 008 00	6 009 00	6 010 00	6 012 00	6 015 00

Channel length	900/900 mm	1,000/1,000 mm	1,200/1,200 mm	1,500/1,500 mm
Visible dimensions following assembly	877.5/877.5 mm	977.5/977.5 mm	1,177.5/1,177.5 mm	1,477.5/1,477.5 mm
	Order No.	Order No.	Order No.	Order No.
Angled channels 90° 	6 109 00	6 110 00	6 112 00	6 115 00

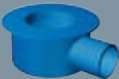
# C



## Drains

	Assembled height	Drainage capacity	Order No.
DN 50 Drain at the side 	95 mm*	0.7 l/s	6 500 00
DN 50 Drain at the side 	120 mm*	0.8 l/s	6 500 01
DN 70 Drain at the side 	148 mm*	1.2 l/s	6 500 02
DN 50 Drain vertical 	65 mm**	1,3 l/s	6 500 03

\*Total assembled height with channel, \*\*channel without assembly feet



# D

## Assembly feet set, 4 pcs.

	Order No.
Assembly feet 92-139 mm 	6 600 03
Assembly feet 137-184 mm 	6 600 04

# E

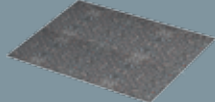
## Drainbase sound insulating mat

	Order No.
1,250 x 1,250 mm Material thickness 6 mm 	6 600 01
Roll L = 8 m/B = 1,250 mm Material thickness 6 mm 	6 600 02



## TECEdrainline – easy-to-care for and hygienic.



The inside gradient of the channel sees to a maximum drainage capacity.

### Care and cleaning

Particular attention was placed on the hygienic aspect when developing the TECEdrainline. The channel body is made of stainless steel and has no gaps and screws which might stand in the way of easy cleaning. The immersion pipe (2nd illustration from r.) can be easily removed for cleaning. Access is ensured in the form of a small hand coil in an emergency such as when the drain is clogged (illustration on the right). A marking inside the drain indicates the position of the drain socket.

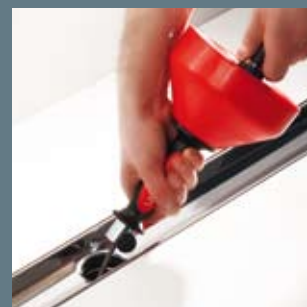

# Draining technology based on standard – made by TECE.

TECE – as one of the few manufacturers – can submit a General Building Test Certificate. Confirmation of compliance with the DIN EN 1253 standard is indicated by LGA Würzburg on the test certificate. Examinations included the drainage capacity, sealing and ease of cleaning of the channels and drains.



Visit us on the Internet and assemble your desired channel online using the shower channel configurator at [www.tece.de](http://www.tece.de).

#### **TECE GmbH**

International Business

Hollefeldstraße 57

48282 Emsdetten

Germany

Phone +49 (0) 25 72 / 928 999

Fax +49 (0) 25 72 / 928 204

[international-business@tece.de](mailto:international-business@tece.de)

[www.tece.biz](http://www.tece.biz)



DS 060 000 60 a

# TECE:

Intelligent housing technology