

# INSTALLATION AND OPERATION INSTRUCTIONS

→ DUAL CLIMA

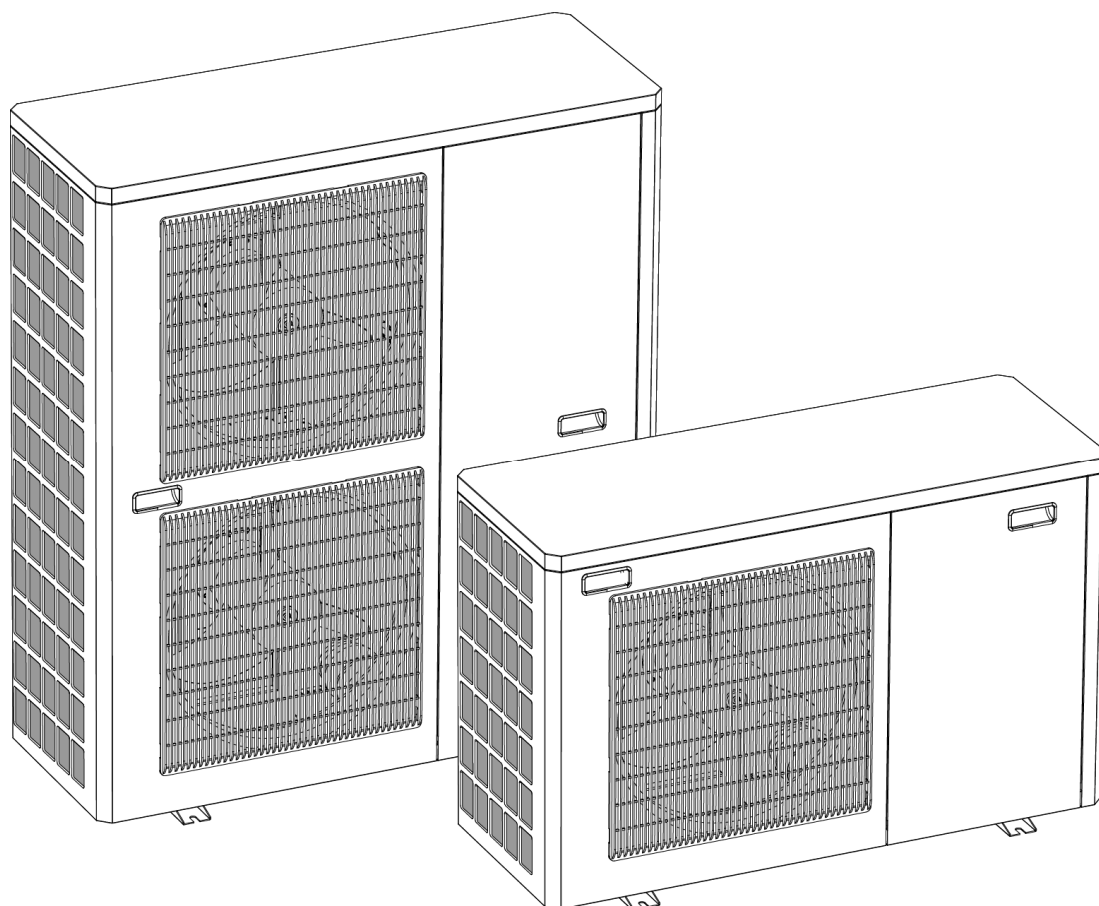

---

**DOMUSA**  
T E K N I K

Thank you for choosing a **DOMUSA TEKNIK** heat pump. From the range of **DOMUSA TEKNIK** products you have chosen the **DUAL CLIMA** model. This is a heat pump capable of providing the ideal level of comfort for your home, always with a suitable hydraulic installation.







This manual forms an essential part of the product and it must be given to the user. Read the warnings and recommendations in the manual carefully, as they contain important information on the safety, use and maintenance of the installation.

This water pump must be installed by qualified personnel only, in accordance with the legislation in force and following the manufacturer's instructions.

The start-up of this heat pump and any maintenance operations must be carried out only by Official Technical Assistance Services of **DOMUSA TEKNIK**.

Incorrect installation of this heat pump could result in damage to people, animals or property, and the manufacturer will not be held liable in such cases.

**CONTENTS**

	<b>Page</b>
1 SAFETY WARNINGS.....	2
1.1 USAGE AND INSTALLATION WARNINGS .....	2
1.2 PERSONAL SAFETY WARNINGS .....	2
1.3 TRANSPORT, STORAGE AND HANDLING WARNINGS .....	3
1.4 FREEZE PROTECTION WARNINGS .....	3
2 ELECTRONIC CONTROLLER .....	4
2.1 CONTROL BUTTONS.....	4
2.2 DIGITAL DISPLAY .....	5
3 SWITCHING THE HEAT PUMP ON AND OFF .....	6
4 OPERATION.....	6
4.1 OPERATING MODE SELECTION.....	6
4.2 AUTO MODE  .....	6
4.3 COOLING MODE  .....	7
4.4 HEATING MODE  .....	7
4.5 DHW MODE  .....	7
4.6 AUTO AND DHW MODE  .....	7
4.7 COOLING AND DHW MODE  .....	8
4.8 HEATING AND DHW MODE  .....	8
4.9 ANTI-LEGIONELLA FUNCTION .....	8
5 TEMPERATURE SELECTION.....	9
5.1 ADJUSTING THE COOLING MODE SETPOINT TEMPERATURE.....	9
5.2 ADJUSTING THE HEATING MODE SETPOINT TEMPERATURE .....	9
5.3 ADJUSTING THE DHW MODE SETPOINT TEMPERATURE.....	10
5.4 ADJUSTING THE ANTI-LEGIONELLA FUNCTION PARAMETERS .....	10
6 ADDITIONAL FUNCTIONS.....	11
6.1 NIGHT MODE.....	11
6.2 OPERATION WITH ROOM THERMOSTAT .....	12
6.3 OPERATION WITH A ROOM SENSOR .....	12
7 CLOCK AND TIMER SETTINGS.....	13
7.1 TIME AND DAY SETTINGS .....	13
7.2 TIMER SETTINGS .....	13
8 OPERATION ACCORDING TO OUTDOOR WEATHER CONDITIONS (AU).....	16
9 INSTALLATION INSTRUCTIONS .....	17
9.1 LOCATION.....	17
9.2 ACCESSORIES SUPPLIED .....	18
9.3 HEAT PUMP FASTENING .....	19
9.4 CONDENSATES DRAINAGE .....	19
9.5 HYDRAULIC INSTALLATION .....	20
9.6 ELECTRICAL CONNECTIONS .....	22
9.7 FREEZE PROTECTION .....	31
10 CONFIGURING THE HEAT PUMP.....	33
11 TECHNICAL MENU.....	33
12 BACKUP SOURCES OF ENERGY SET UP (E1, E2).....	34
12.1 BACKUP SOURCE MODE (P27 = 0).....	35
12.2 AUXILIARY SOURCE MODE (P27 = 1).....	35
13 COMMISSIONING.....	36
13.1 PRIOR WARNINGS .....	36
13.2 START-UP.....	36
13.3 EQUIPMENT DELIVERY .....	36
14 MAINTENANCE .....	37
15 CIRCULATION PUMP AND PRESSURE DROP DIAGRAMS .....	38
16 PERFORMANCE AND EFFICIENCY DIAGRAMS.....	39
17 TECHNICAL CHARACTERISTICS.....	42
18 DIAGRAMS AND MEASUREMENTS .....	43
19 ELECTRICAL DIAGRAMS .....	44
19.1 NOMENCLATURE .....	44
19.2 DUAL CLIMA 8 .....	45
19.3 DUAL CLIMA 11 .....	46
19.4 DUAL CLIMA 16.....	47
20 ALARM CODES.....	48

# DUAL CLIMA

## 1 SAFETY WARNINGS

### 1.1 Usage and installation warnings

**DUAL CLIMA** heat pump must be installed by personnel authorised by the Ministry of Industry, in compliance with the applicable laws and regulations. The precautions detailed here cover very important issues. Please be sure to follow them carefully.

Read carefully this instruction manual and keep it in a safe, easily-accessible place. **DOMUSA TEKNIK** will not be liable for any damages caused by failure to follow these instructions.

This heat pump is suitable for use in both heating and cooling installations and can be combined with fan coils, underfloor heating/cooling, low-temperature radiators, and domestic hot water tanks (optional). It must be connected to a heating/cooling installation and/or a domestic hot water distribution network and compatible with its performance and power.

This appliance must only be used for the purpose for which it has been expressly designed. Any other use is considered unsuitable and therefore hazardous. The manufacturer shall not be considered liable under any circumstances for damage caused by unsuitable, erroneous or irrational use.

Remove all the packaging and check the contents are complete. In case of doubt, do not use the heat pump. Contact your supplier. Keep the packaging elements out of reach of children, as they can be dangerous.

Improper installation or placement of equipment or accessories may cause electrocution, short circuit, leakage, fire, or other damage to the equipment. Use only accessories or optional equipment manufactured by **DOMUSA TEKNIK** and designed specifically to work with the products presented in this manual. Do not modify, replace or disconnect any safety or control device without first consulting the manufacturer or the Official Technical Assistance Service of **DOMUSA TEKNIK**.

When it is decided not to use any more the heat pump, disable the parts that could represent a potential hazard.

### 1.2 Personal safety warnings

Always wear appropriate personal protective equipment (gloves, safety goggles, etc.) when performing installation and/or maintenance on the unit.

Do not touch any switch with wet fingers. Touching a switch with wet fingers may cause electric shock. Before accessing the electrical components of the heat pump, disconnect the main power supply completely.

Disconnect all electricity sources before dismantling the cover panel from the electric panel or before making any connections or accessing electrical parts.

To avoid electrocutions, be sure to turn off the power for 1 minute (or more) before servicing the electrical parts. Even after 1 minute, always measure the voltage at the terminals of the main circuit capacitors and other electrical parts before touching them and make sure that the voltage is equal to or less than 50 Vdc.

When the cover panels are disassembled, the energised parts can be easily accessed. Never leave the unit unattended during installation or during maintenance work when the cover panel is removed.

Do not touch the coolant pipes, water piping, or internal parts during and immediately after operation. Pipes and internal parts may be excessively hot or cold, depending on the use of the unit.

The hands may be burned by cold or heat in case of improperly touching pipes or internal parts. To avoid injury, wait until the pipes and internal parts return to their normal temperature. Alternatively, if access is required, be sure to wear appropriate safety gloves.

### 1.3 Transport, storage and handling warnings

**DUAL CLIMA** heat pump must be transported, handled and stored vertically. Tipping the machine may cause the oil to be emptied inside the compressor, causing premature rupture of the machine when the machine is started.



The heat pump packaging has a **"tilt indicator"** label to ensure that the machine has not been overturned during transport and storage. **Before receiving the machine from your supplier (distributor), check the status of this indicator and refuse the device without unpacking it if the warning switch of the label indicates that it has been overturned.**

Do not twist, loosen or pull the external electric cables of the heat pump. Do not insert any sharp objects through the fan grille or into the fan itself.

Do not wash the interior of the heat pump with water as this may result in electric shock or fire. For any cleaning and/or maintenance operations, disconnect the main power supply.

### 1.4 Freeze protection warnings

**DUAL CLIMA** heat pump is a machine that is installed in the exterior of the house, so that it will be exposed to the extreme climatic conditions of cold in the periods of frost. Due to this, it is of paramount importance that this type of machine is protected against such frost. The freezing of the water inside the heat pump causes the heat pump to breakdown, with the subsequent interruption of its operation and major economic expenses involving its repair.

It is **mandatory** to use a safety system in the installation to prevent the freezing of water in the machine. **DOMUSA TEKNIK** proposes the use of glycol in the water circuit of the pump, or some antifreeze valve system to empty the installation in conditions of low temperatures. Carefully read the *"Freeze Protection"* section in this manual for more detailed information on these systems. **DOMUSA TEKNIK** will not cover damages caused by the lack of any of these antifreeze safety systems.

# DUAL CLIMA

The electronic controller of the **DUAL CLIMA** heat pump has a function for protection against the freezing of the water in its interior in periods of frost. For this function to remain active and on alert, the heat pump must be connected to the mains and have a power supply, even if it is switched off or not in use.

A water filter should be installed in the installation, in order to avoid obstructions in the water circuit of the heat pump. It must be installed in the return circuit of the heat pump and **MUST** be installed before filling and circulating the water through the installation. The water filter should be checked and cleaned, if necessary, at least once a year. IN new installations, however, it is advisable to check it within the first few months of its commissioning.

## 2 ELECTRONIC CONTROLLER

### 2.1 Control buttons

The electronic controller of the **DUAL CLIMA** heat pump has 6 control buttons, through which all the features and adjustable settings can be managed.

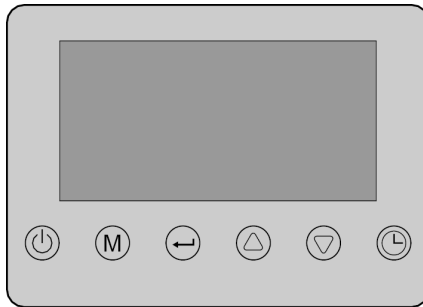

- Power button:** This button switches the heat pump on and off. It can also be used to exit the different adjustment menus (Escape key).
- Mode button:** This button selects the operating mode.
- Confirmation button:** This button saves and confirms the selected adjustment value.
- Adjustment buttons:** Pressing these buttons increases and decreases the selected adjustment value. It can also be used to navigate within the different adjustment menus.
- Clock button:** This button accesses the adjustments related to the time and time programming of the heat pump.

## 2.2 Digital Display

The controller of the **DUAL CLIMA** heat pump incorporates a digital display for the viewing and adjustment of the different parameters of the heat pump. The display has different display areas and sets of icons and numbers that indicate the different statuses of the heat pump.

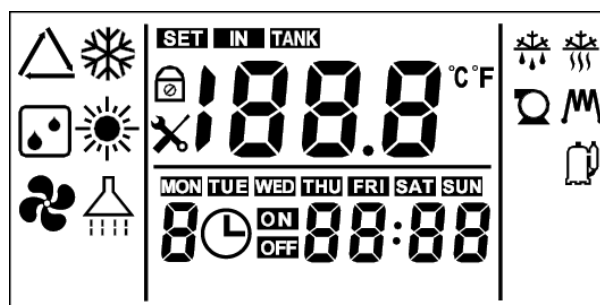

Operating modes:	
	AUTO mode enabled.
	Cooling Mode enabled.
	Heating Mode enabled.
	DHW Mode enabled.

Additional functions:	
	Anti-legionella Function enabled.
	Antifreeze Function enabled.
	Defrost Function activated.
	Room Thermostat function.
	Alarm display.





Temperature display:	
<b>188.8</b>	Numerical display.
<b>°C</b>	Temperature unit, Celsius degrees.
<b>SET</b>	Temperature adjustment.
<b>IN</b>	Heat pump water temperature.
<b>TANK</b>	Temperature of the DHW tank.

Clock Timer:	
<b>88:88</b>	Time digits.
	Time programmer adjusted.
<b>1</b>	On programming point (1, 3 or 5).
<b>2</b>	Off programming point (2, 4 or 6).
	Time schedule activated.

Indication of active components:	
	Water circulator pump activated.
	Compressor activated.
	Resistor or auxiliary energy activated.
	Fan activated.

# DUAL CLIMA

## 3 SWITCHING THE HEAT PUMP ON AND OFF







To turn on the heat pump press the button . The heat pump will turn on in the last operating mode previously selected and at least one of the operating mode icons (     ) will appear on the digital display.

To turn off the heat pump, press the button  again. The heat pump will proceed to the shutdown sequence and all operating mode icons on the digital display will disappear.

## 4 OPERATION

### 4.1 Operating mode selection

Depending on the set-up of your installation, the **DUAL CLIMA** heat pump will be able to manage up to 7 different operating modes. To select these operating modes, press the button  successively. The following modes will be displayed:

-  AUTO mode.
-  Cooling Mode.
-  Heating Mode.
-  Domestic Hot Water (DHW) Mode.
-  AUTO and DHW mode
-  Cooling and DHW mode
-  Heating and DHW mode

Depending on the configuration of your installation, some of the operating modes listed may not be selectable. Please read carefully the following sections, which describe in detail the operation of these modes.

### 4.2 AUTO mode

This mode is selectable only if the heating/cooling installation is ready for operation in Cooling mode (cooling floor, fan coils, etc.) and the heat pump is configured for this purpose. **AUTO mode is incompatible to work together with a room thermostat, so it is not recommended to select this mode if there is any installed.**

In this operating mode, the electronic controller of the heat pump, depending on the temperature outside the home, will automatically decide when to activate the heating or cooling mode of the heating/cooling installation. If the outside temperature is below 15 °C, the heating mode will be activated; if the outside temperature is above 25 °C, the cooling mode will be activated. If the outside temperature is between 16 ~ 24 °C, the heating pump will stop heating or cooling and it will stay in Stand By mode until the outside temperature increases or decreases up to the temperatures indicated before. For more information on each of these operating modes, read the following sections of the manual carefully.

This mode will operate **only** on the heating/cooling installation, disabling the DHW production service, if any.



### 4.3 Cooling mode

This mode is selectable only if the heating/cooling installation is ready for operation in Cooling mode (cooling floor, fan coils, etc.) and the heat pump is configured for this purpose.

In this operating mode, the **DUAL CLIMA** heat pump will cool and keep the water in the heating/cooling installation at the desired temperature. To do this, select the desired cooling temperature setpoint (see "*Temperature Selection*") and the temperature of the room thermostat (if any) (see "*Operation with Room Thermostat*").

This mode will operate **only** on the heating/cooling installation, disabling the DHW production service, if any.

### 4.4 Heating mode

In this operating mode, the **DUAL CLIMA** heat pump will heat and maintain the water in the heating/cooling installation at the desired temperature. To do this, select the desired heating temperature setpoint (see "*Temperature Selection*") and the temperature of the room thermostat (if any) (see "*Operation with Room Thermostat*").

This mode will operate **only** on the heating/cooling installation, disabling the DHW production service, if any.

### 4.5 DHW mode

This mode will be selectable only if the installation has a Domestic Hot Water tank connected and the heat pump is configured for it.

In this operating mode, the **DUAL CLIMA** heat pump will heat the domestic water of the DHW tank up to the desired temperature, allowing Domestic Hot Water service to the home. To do this, select the desired DHW setpoint temperature (see "*Temperature Selection*"). Once the desired temperature has been reached, the heat pump will stop and wait to receive the DHW demand.

This mode will operate **only** on the installation of the DHW tank, disabling the heating and/or cooling installation of the heating/cooling installation.

### 4.6 AUTO and DHW mode +

This mode will be selectable only if the heating/cooling installation is ready to operate in Cooling mode (cooling floor, fan coils, etc.); the installation has a connected domestic hot water tank and the heat pump is configured for it. **AUTO mode is incompatible to work together with a room thermostat, so it is not recommended to select this mode if there is any installed.**

This operating mode is the combination of the AUTO and DHW modes simultaneously. When the DHW demand is enabled, the heat pump will disable the heating or cooling service and enable the Hot Domestic Water production mode, with the production of priority DHW relating to the heating or cooling of the heating/cooling installation. Once the desired DHW temperature is reached, the heat pump will re-enable automatic heating or cooling of the installation (see "*AUTO Mode*").

## DUAL CLIMA

### 4.7 Cooling and DHW mode +

This mode will be selectable only if the heating/cooling installation is ready to operate in Cooling mode (cooling floor, fan coils, etc.); the installation has a connected domestic hot water tank and the heat pump is configured for it.

This operating mode is the combination of the Cooling and DHW simultaneously. When the DHW demand is enabled, the heat pump will disable the Cooling mode and will enable the Domestic Hot Water production mode, with the production of priority DHW relating to the cooling of the heating/cooling installation. Once the desired DHW temperature is reached, the heat pump will re-enable the Cooling mode.

### 4.8 Heating and DHW mode +

This mode will be selectable only if the installation has a Domestic Hot Water tank connected and the heat pump is configured for it.

This operating mode is the combination of the Heating and DHW modes simultaneously. When the demand for DHW is activated, the heat pump will disable the Heating mode and will enable the Hot Domestic Water production mode, with the production of priority DHW relating to the heating of the heating/cooling installation. Once the desired DHW temperature is reached, the heat pump will re-enable the Heating mode.



### 4.9 Anti-Legionella function

This function prevents the proliferation of Legionella bacteria in the domestic hot water stored in the tank, so it will only be available if the installation has a connected Domestic Hot Water tank and the heat pump is configured for it. In addition, in order to make the function effective, it will be essential for the tank to have a heating component installed, in order to reach the temperatures required to eradicate the bacteria.

The function will periodically raise the temperature of the Domestic Hot Water from the tank to a temperature of 60~70 °C. To do this, the desired temperature and periodicity can be selected (see "*Temperature Selection*"). This function will be activated regardless of the operating modes that are activated at the time of starting, even when the heat pump is in Standby mode.

In addition, it is possible to activate this function manually, keeping the button  pressed during 5 seconds. Once the function is activated, it is not possible to stop it and it will have to wait until it finished, in order that the machine returns to its normal operation.

## 5 TEMPERATURE SELECTION

The desired setpoint temperatures for each operating mode can be adjusted by means of a temperature selection menu. To access it, with the heat pump on (button ) , keep buttons  +  pressed simultaneously during 3 seconds. The display will show the cooling setpoint temperature flashing:

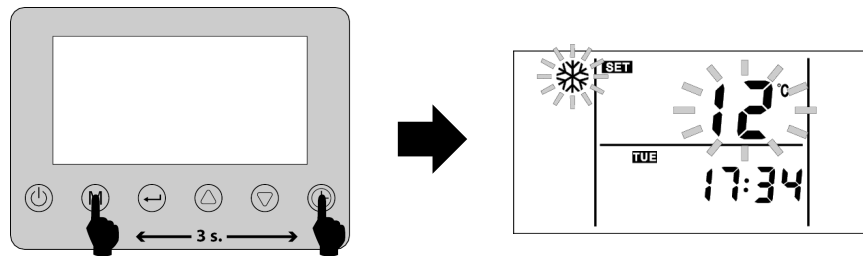



On the menu, successively press  to browse through all setpoint settings of the different operating modes available:



The following sections describe in detail the process of setting the temperature setpoint for each mode. Once the desired setpoints are set, press  to exit the temperature selection menu. If a period of more than 15 seconds of inactivity (no buttons pressed) is detected, the electronic controller will automatically exit the menu.

### 5.1 Adjusting the cooling mode setpoint temperature

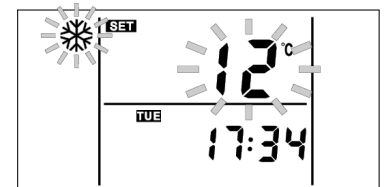

The selectable value range for the Cooling mode is 10~25°C. The default factory value is 12 °C, and by means of   buttons it may increase or decrease, respectively. Once the desired value has been selected, press  button to save it.



For the correct adjustment of the appropriate value of this operating mode, the recommendations of the installer or official Technical Service of **DOMUSA TEKNIK** should be followed. Depending on the type of installation, the location (climatic zone) and the relative humidity of the home, excessively low temperatures of the Cooling mode setpoint may create "undesired" condensations in the heating/cooling installation, causing deterioration and damage in the home.

**IMPORTANT: DOMUSA TEKNIK will not be held liable for any damage and/or faults, in either the installation or the home, caused by an inadequate selection of the setpoint temperature of the Cooling mode.**

### 5.2 Adjusting the heating mode setpoint temperature

The selectable value range for the Heating mode is AU, 10~25 °C. The default factory value is 45 °C, and by means of   buttons it may increase or decrease, respectively. Once the desired value has been selected, press  button to save it.

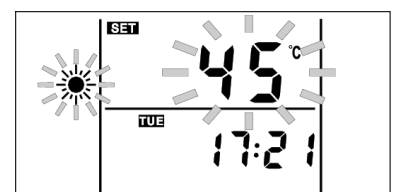



## DUAL CLIMA

In addition to the temperature values, in the Heating mode, the "AU" value can be selected as the setpoint, by pressing  after selecting the value 10 °C. Select this value to enable the operation according to the outdoor weather conditions for that mode. The adjustment of the setpoint temperature will be carried out automatically by the electronic controller according to the temperature measured outside the home, according to operating curves pre-set by the installer or the Official Technical Assistance Service (see "Operation According to Outdoor Weather Conditions").

**NOTE: If automatic operation is selected according to the external climatic conditions ("AU"), an incorrect adjustment of the operating curves may cause the heating installation not to generate the desired comfort in the home, failing to provide heating in extreme weather conditions of cold and/or causing overheating in hot weather conditions.**

### 5.3 Adjusting the DHW mode setpoint temperature

The selectable value range for the DHW mode is 10~60 °C. The default factory value is 50 °C, and by means of   buttons it may increase or decrease, respectively. Once the desired value has been selected, press  button to save it.

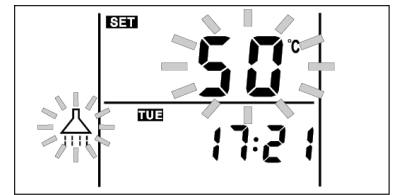



If the desired temperature in the tank is higher than 50 °C, it is essential to install an auxiliary heat source in the tank (electric heating resistor, auxiliary boiler, etc.). The **DUAL CLIMA** heat pump will heat the water in the tank to 50 °C and, from this temperature, activate the auxiliary source to reach the desired upper temperature.

### 5.4 Adjusting the Anti-Legionella function parameters



The operation of the anti-legionella function will depend on 4 adjustable parameters, which will be selected by successive press of  button.

#### Anti-Legionella Temperature

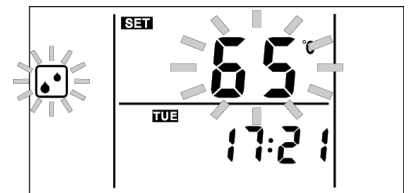
The selectable value range for the Anti-Legionella function is 60~70 °C. The default factory value is 65 °C, and by means of   buttons it may increase or decrease, respectively. Once the desired value has been selected, press  button to save it.



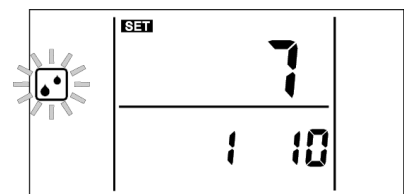

#### Frequency

This parameter adjusts the periodicity (in days) at what the anti-legionella function will be activated. The selectable value range is 7~99 days. The default factory value is 7 days, and by means of   buttons it may increase or decrease, respectively. Once the desired value has been selected, press  button to save it.



#### Start Time

This parameter adjusts the time at what the anti-legionella function will be activated. The selectable value range is 0~23 hours. The default factory value is 1 (at 1:00 am), and by means of   buttons it may increase or decrease, respectively. Once the desired value has been selected, press  button to save it.

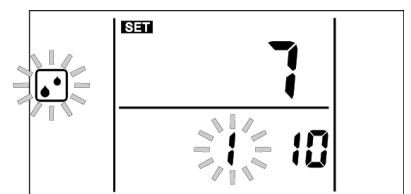

## **Maintenance Minutes**

This parameter adjusts the time during which the function will continue activated once the selected temperature is reached. The selectable value range is 10~99 minutes. The default factory value is 10 minutes, and by means of  $\triangle$   $\nabla$  buttons it may increase or decrease, respectively. Once the desired value has been selected, press  $\rightarrow$  button to save it.

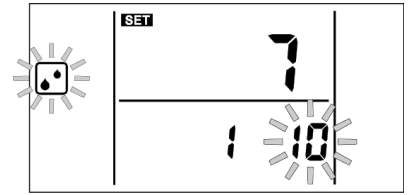

For the anti-legionella function to raise the temperature of the tank to a temperature between 60~70 °C, it is essential to install an auxiliary heat source in the tank (electric heating resistor, auxiliary boiler, etc.). The **DUAL CLIMA** heat pump will heat the water in the tank to 50 °C and, from this temperature, activate the auxiliary source to reach the adjusted temperature. If this auxiliary heating source is not available, the heat pump will heat the water in the tank to 50 °C and keep the temperature for 80 minutes before deactivating the function.

**NOTE: In case of not having an auxiliary heating source that allows raising the DHW temperature above 60 °C, the anti-legionella function will not ensure the eradication of said bacteria.**

## **6 ADDITIONAL FUNCTIONS**

### **6.1 Night Mode**

With the aim of reducing the number of activations and the sound impact of the heat pump during particularly sensitive times (night), the **DUAL CLIMA** heat pump allows the activation of the Night operating mode. During the Night operating mode, the DHW will automatically raise the adjusted setpoint temperature by +3 °C, the Heating mode will automatically reduce its setpoint temperature by -2 °C, and finally, the Cooling mode will automatically raise its setpoint temperature by +2 °C. In addition, to reduce the noise impact, the outdoor fan will operate at low speed.

To activate and configure this operating mode, parameters **P47**, **P48** and **P49** should be set in the Technical menu (see "*Technical Menu*"). The heat pump is supplied by default with the Night mode activated. To deactivate it, parameter **P47** must be set to value **0**. In addition, the start time of Night mode will be selected through parameter **P48** while the end time will be selected through parameter **P49**. The pre-adjusted factory time is from 10:00 pm to 06:00 pm.

# DUAL CLIMA

## 6.2 Operation with room thermostat

The **DUAL CLIMA** heat pump incorporates a connection prepared for the installation of a room chrono-thermostat or room thermostat (see *"Room Thermostat Installation"*), which will allow the operation of the heat pump to be controlled depending on the temperature in the interior of the home. Optionally, **DOMUSA TEKNIK** offers a wide range of such devices in its product catalogue.

Once the thermostat is installed in your home, select the desired temperature and operating periods, if it is a chrono-thermostat (see the Room-Thermostat Manual). The heat pump will turn on and activate the heating/cooling operation mode selected in it (AUTO, Heating or Cooling) until the temperature set in the room thermostat is reached. When the desired temperature in the home is reached, the heating and/or cooling service of the heating/cooling installation will be disabled, shutting down the operation of the heat pump. The screen of the electronic controller will display the  icon, showing that the heat pump has been switched off by the room thermostat (Standby).

**Room thermostat operation is incompatible with AUTO mode, so it is not recommended to select AUTO mode if there is any installed.**

The operation with the room thermostat will not affect the DHW service, keeping it enabled regardless of the status of the thermostat.

The installation of a room thermostat will optimise the installation's performance, adapting the heating and/or cooling to the requirements of your home and obtaining enhanced comfort. Additionally, if the thermostat allows the operating hours to be programmed (chrono-thermostat), it can adapt the installation to the hours of use of the installation.

## 6.3 Operation with a room sensor

The **DUAL CLIMA** heat pump incorporates a connection prepared for the installation of a room temperature sensor (see *"Room Sensor Installation"*), through which the electronic controller will be able to read the temperature in the interior of the home, allowing the management of the installation of heating/cooling depending on the temperature of the interior of your home. The room sensor is supplied as an optional accessory of the heat pump, except for the PACK items of the aérothermal line, in which it will be supplied by default within the PACK.

Once the room sensor is installed in your home, select the desired room temperature, adjusting it in parameter **P29** of the Technical menu (see *"Technical Menu"*). In addition, the Heating temperature and Cooling temperature of the heat pump (if any) should be adjusted (see *"Temperature Selection"*). The heat pump will turn on and activate the heating/cooling operating mode selected in it (AUTO, Heating or Cooling) until the set temperature is reached in the heat pump. In turn, the circulation pump of the heating/cooling installation will be activated until the desired room temperature is reached (set in parameter **P29** of the Technical menu). When the desired room temperature is reached in the home, the circulator pump of the heating/cooling installation will be deactivated, delivering no heat or cold to the room.











The operation with the room sensor will not affect the DHW service (if any), keeping it enabled regardless of the status of the thermostat.

The installation of a room sensor will optimise the installation's performance, adapting the heating and/or cooling to the requirements of your home and providing enhanced comfort features. In addition, by means of the programming integrated into the heat pump, the service can be adapted to the hours of use of the installation.

## 7 CLOCK AND TIMER SETTINGS

The **DUAL CLIMA** heat pump integrates a time and date display, through which some functions are managed. It is thus essential to set the correct date and time when commissioning the heat pump. In addition, this clock can be used to set the periods for turning on and off the desired operating modes for each day of the week (weekly programming).



### 7.1 Time and day settings

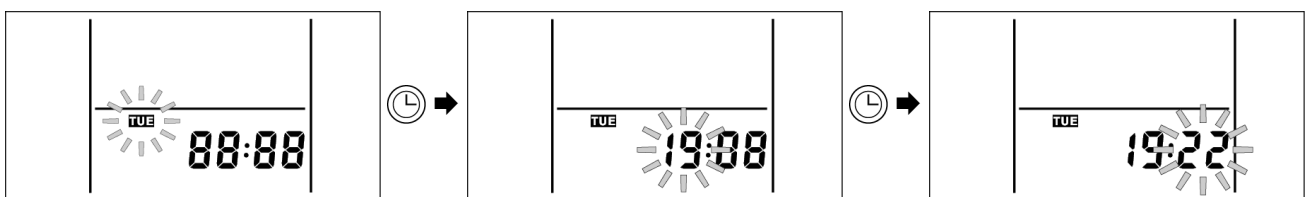



To set the time and day of the week, press  and the day of the week symbol will flash. Use buttons   to select the day of the week and press  to confirm. Next, the hour digits will flash. Use buttons   to select the hour and press  to confirm. Finally, the minute digits will flash. Use buttons   to select the minutes and press  to confirm the selected value. The time setting mode will close automatically.





### 7.2 Timer Settings

The **DUAL CLIMA** heat pump has a weekly timer function, through which the on and off periods can be set, as well as the desired operating modes in each of them. In one day, 3 points can be set for the activation (mode selection) and 3 points for the total shutdown of the pump. Points **1**, **3** and **5** enable the desired operating mode. Points **2**, **4** and **6** disable all operating modes that were active at the programmed time.

The start and shutdown points may be adjusted independently from each other, i.e. it is not necessary to adjust them in pairs (1 with 2, 3 with 4, etc.). Only the start points (1, 3 and 5) can be adjusted in such a way that they change the operating mode each time the programmed time is reached for each of them (e.g. point 1: 06:00h  + , point 3: 21:00h , daytime activation in Heating mode, keeping the DHW service active for 24 hours).

When the programmer is set, the programming symbol will appear permanently enabled () on the electronic controller screen, indicating that time programming is enabled. To restore the manual operation and erase all settings of the time programmer, simultaneously press and holding buttons  +  for 3 seconds. The programming symbol () will be disabled on the screen.

To access the setting mode of the time programmer press and hold the  button for 3 seconds. The symbol  will flash on the screen, as well as the and the start point **1** for said day.

# DUAL CLIMA

## Adjusting the start points (points 1, 3 and 5)

1.- After accessing the adjustment mode, use buttons  $\triangle$   $\nabla$  to select the day of the week to be programmed and press  $\leftarrow$  to confirm.



2.- The digit of the programming points will flash. Use buttons  $\triangle$   $\nabla$  to select the desired start point (1, 3 or 5) and press  $\leftarrow$  to confirm.



3.- The digits of the time will flash. Use buttons  $\triangle$   $\nabla$  to select the desired on time and press  $\leftarrow$  to confirm.



4. The digits of the minutes will flash. Use buttons  $\triangle$   $\nabla$  to select the minutes and press  $\leftarrow$  to confirm.



5.- The operating mode symbol  $\triangle$  will flash. Use buttons  $\triangle$   $\nabla$  to select the operating mode to be switched on and press  $\leftarrow$  to confirm.

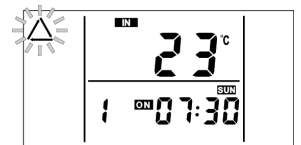

6.- The symbol  $\odot$  will flash. Press  $\triangle$  to activate the adjusted start point. The symbol  $\odot$  will stop flashing and will remain still, indicating that it is enabled.



7.- Once the start point is turned on, press  $\leftarrow$  to and repeat the process from step 1 to adjust more points.

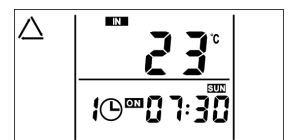



If you wish to deactivate a previously activated start point, select the point you wish to deactivate (Step 2), press  $\leftarrow$  to advance through the adjustment mode until the fixed programming symbol  $\odot$  (Step 6) is displayed, and finally, press  $\nabla$  to disable the start point. The symbol  $\odot$  will flash, indicating that it is disabled. Press  $\leftarrow$  again to keep adjusting the programmer.



After adjusting all desired programming points, press  $\odot$  to exit the adjustment mode.





**Adjusting the shutdown points (points 2, 4 and 6)**

- 1.- After accessing the adjustment mode, use buttons   to select the day of the week to be programmed and press  to confirm.





- 2.- The digit of the programming points will flash. Use buttons   to select the desired shutdown point (2, 4 or 6) and press  to confirm.



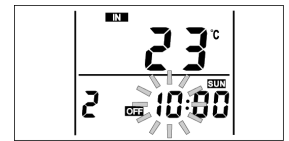

- 3.- The digits of the time will flash. Use buttons   to select the desired off time and press  to confirm.



- 4.- The digits of the minutes will flash. Use buttons   to select the minutes and press  to confirm.







- 5.- The symbol  will flash. Press  to activate the adjusted shutdown point. The symbol  will stop flashing and will remain still, indicating that it is enabled.

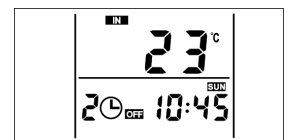

- 6.- Once the shutdown point is turned on, press  to and repeat the process from step 1 to adjust more points.



If you wish to deactivate a previously activated shutdown point, select the point you wish to deactivate (Step 2), press  to advance through the adjustment mode until the fixed programming symbol  (Step 5) is displayed, and finally, press  to disable the shutdown point. The symbol  will flash, indicating that it is disabled. Press  again to keep adjusting the programmer.

After adjusting all desired programming points, press  to exit the adjustment mode.

**NOTE: Each time the timer reaches at a shutdown point (2, 4 and 6), all operating modes that are active at that moment will be deactivated (total shutdown of the heat pump).**

# DUAL CLIMA

## 8 OPERATION ACCORDING TO OUTDOOR WEATHER CONDITIONS (AU)

This operating mode enables the electronic controller of the **DUAL CLIMA** heat pump to calculate the heating temperature depending on the outdoor temperature conditions (OTC) at each particular time, with optimal adjustment of the heating installation conditions for improved comfort in the home and energy savings.

To activate this operation, select the value "AU" as the setpoint temperature of the Heating mode (see "Temperature Selection"). The Heating temperature will be calculated automatically by the electronic controller according to the temperature measured outside the home, according to the following operating curves. The selection of the operating curve must be made by technically qualified personnel. To configure the desired curve, parameters **P45** and **P46** of the Technical menu should be adjusted.

### Parameter P45

Use parameter **P45** to adjust the **offset**, horizontally shifting the curve in the graph. The selectable value range is -10~15 °C. The default factory value is 0 °C and, once the parameter is selected on the Technical menu, buttons  $\triangle$   $\nabla$  can be used to increase or decrease this value, respectively (see "Technical Menu"). Once the desired value has been selected, press  $\leftarrow$  button to save it.

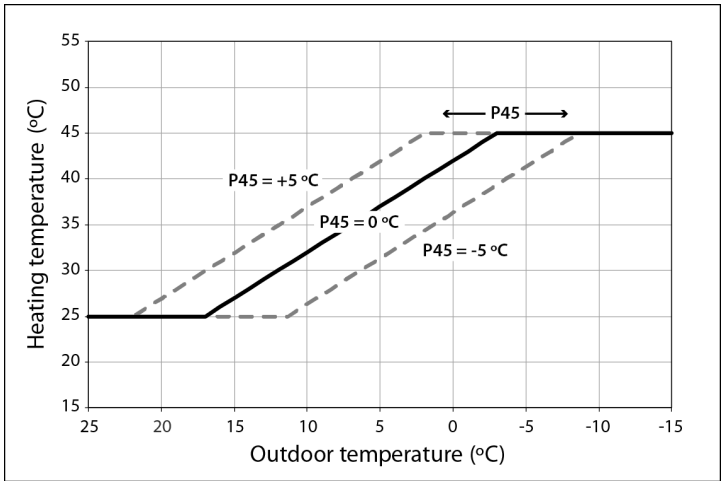

### Parameter P46

Parameter **P46** will adjust the **slope** of the curve and the maximum temperature of the Heating mode. The selectable value range is 30~50 °C. The default factory value is 45 °C and, once the parameter is selected on the Technical menu, buttons  $\triangle$   $\nabla$  can be used to increase or decrease this value, respectively (see "Technical Menu"). Once the desired value has been selected, press  $\leftarrow$  button to save it.

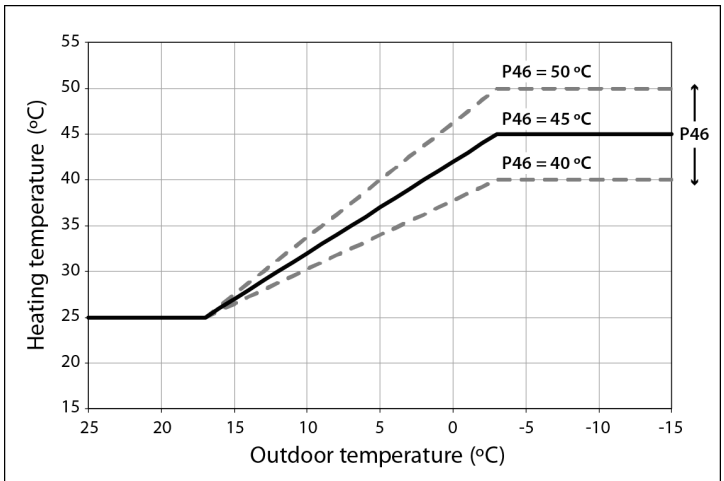

**NOTE: An incorrect adjustment of these operating curves may cause the heating installation not to generate the desired comfort in the home, failing to provide heating in extreme weather conditions of cold and/or causing overheating in hot weather conditions.**

## 9 INSTALLATION INSTRUCTIONS

### 9.1 Location

The heat pump must be installed exclusively outside the home and, where possible, in a completely clear area. If a protection is needed around the appliance, it should have wide openings on the 4 sides and the installation separations indicated in the following figure must be respected. No obstacle should prevent the circulation of air through the evaporator and at the fan outlet.

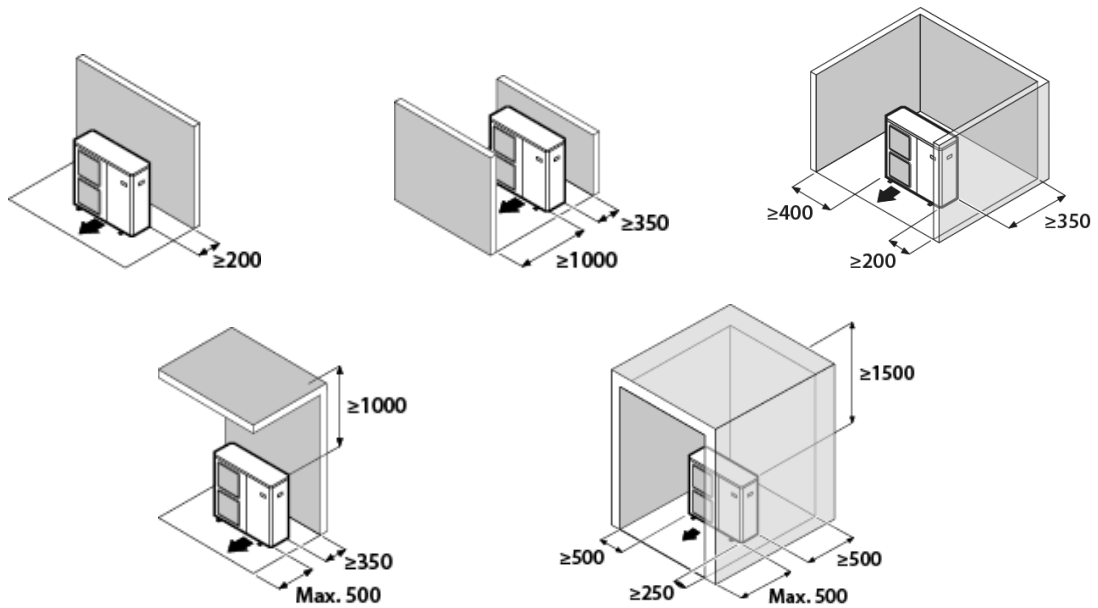

Minimum separations for the installation of a unit (mm).

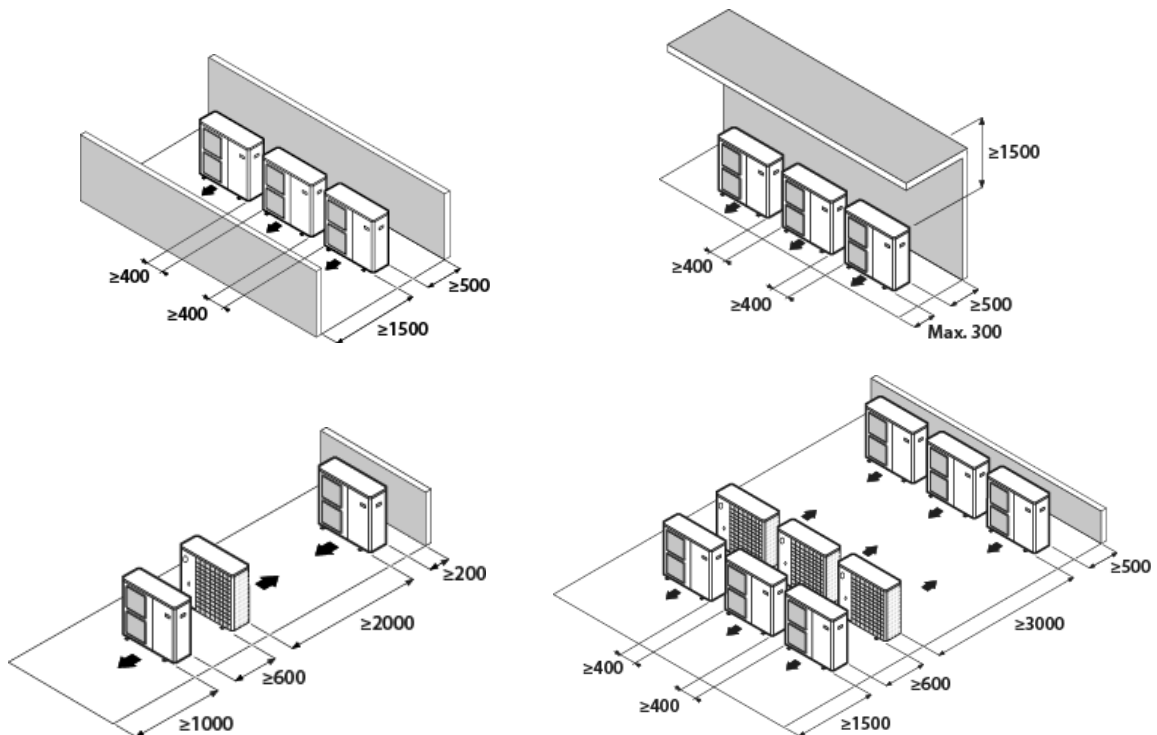

Minimum separations for the installation of multiple units in the same location (mm).

# DUAL CLIMA

Consult with the user before choosing the location of the device. It should not be placed next to sensitive walls, such as on the wall next to a bedroom. Make sure that the location of the heat pump is not disruptive to neighbours (sound level, air currents generated, low temperature of the air blown with risk of freezing plants in the path, etc.).

Choose a location that preferably has sunlight and is protected from strong and cold winds. If the heat pump is exposed to gusts of wind that make it possible to overturn it, it should be supported by suitable guys, as indicated in the figure.

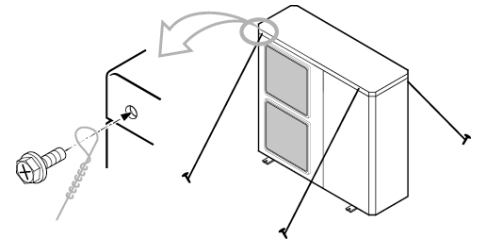

The device must be sufficiently accessible for subsequent installation and maintenance work. Make sure that the passage of the hydraulic and electrical connections to the interior of the house is possible and comfortable. The spacing measures indicated in the figure above are those strictly necessary to ensure correct operation of the device; however, sometimes, it will be essential to provide more space for maintenance work.

The **DUAL CLIMA** heat pump is a device specially designed for outdoor installation. Nevertheless, avoid installing it in a place where it may be exposed to significant water stains or spills (e.g. under a faulty gutter, near gas outlets, etc.). Move the appliance away from heat sources and flammable products.

In areas where abundant and copious snowfalls occur, special care must be taken to protect the heat pump from possible obstructions due to accumulation of snow around it. The obstruction of the air inlet and/or outlet of the machine due to the accumulation of snow may cause malfunction of the unit and possible breakdowns. The heat pump must be raised at least 100 millimetres above the maximum expected snow level. In turn, the roof should be protected from accumulation of snow, by means of a roof projecting from the building or a similar structure.

## 9.2 Accessories Supplied

The following accessories are supplied in the interior of the **DUAL CLIMA** heat pump. Before proceeding with the installation of the machine, make sure that you receive them and that they are in good condition.



**Documentation:** Inside the machine, open the front door to find the documentation bag, where all the manuals and documents necessary for the use and installation of the heat pump are included.

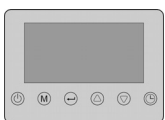

**Main board:** It is supplied inside the machine and can be found by removing the cover of the electronic boards. Before connecting the power supply to the machine, the control panel should be installed inside the house.



**Drain valve:** It is supplied inside the machine, tied with a flange to one leg of the compressor. This key must be installed in the drain socket on the back of the heat pump before filling the water in the heating/cooling circuit (see "Diagrams and Measurements").

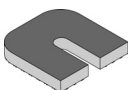

**4x Anti-vibration dampers:** Four units are supplied in a bag stuck on the back of the machine, next to the hydraulic outlets.

### 9.3 Heat Pump fastening

The heat pump should be firmly fixed to a base, preferably a concrete base. Fasten it firmly using 4 sets of M12 bolts suitable for the base material, with nuts and washers (available on the market). Make sure that the protruding distance of the bolt does not exceed 10 mm inside the metallic support of the device (leg).

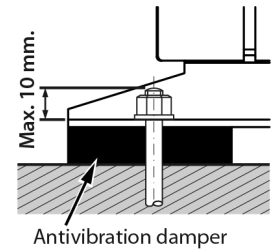

The receiving surface of the device must:

- Allow a solid fixation (preferably concrete).
- Fully support its weight.
- Have a permeable area below the condensate drainage hole (earth, gravel bed, sand, etc.).
- Do not transmit any vibration to the home, recommending the installation of the antivibration dampers supplied with the heat pump.

In case of installing the device on wall mounts, it will be especially important to isolate the machine from the transmission of vibrations and noise inside the house, it may be necessary to install more suitable antivibration dampers for the wall mount in addition to those supplied with the heat pump. Nevertheless, the installation on the ground is the most advisable.

**Straighten** the heat pump well to ensure that the condensate water cannot exit through any paths other than the intended drain hole.

### 9.4 Condensates Drainage

In normal operation, the heat pump can evacuate large amounts of water, for which the **DUAL CLIMA** heat pump provides a hole in the bottom of the appliance. Be sure not to obstruct this hole during the installation process of the appliance.

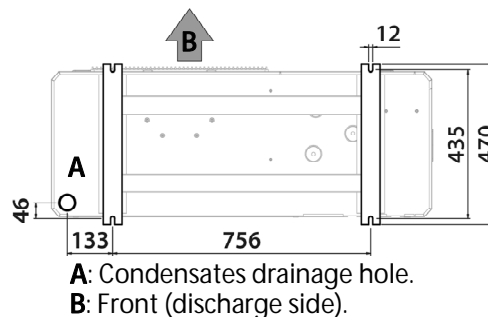

Preferably install the device in a well-drained place. To do this, it is advisable to provide a bed of gravel, sand or similar materials below said hole. If the drain hole of the heat pump is covered by a mounting base or by the floor, lift the unit to leave a free space of at least 100 mm below it.

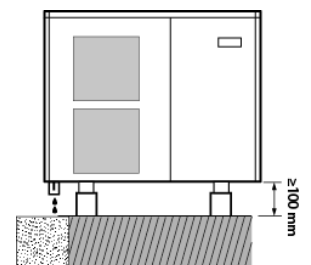

If it is installed on a terrace or façade, the condensate outlet must be led to a drain to avoid inconvenience and/or damage caused by the dripping of condensate water. If the installation is carried out in a region where the temperature can be below 0 °C for a long period of time, check that the presence of frost does not represent any danger.

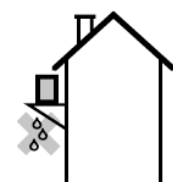

# DUAL CLIMA

## 9.5 Hydraulic installation

The hydraulic installation must be made by qualified personnel. The applicable installation legislation must be complied with, and the following recommendations should also be taken into account:

- It is advisable to use Ø28 mm pipes (**DN25**) for the installation. The inside of the installation piping should be thoroughly cleaned before switching on the heat pump.
- All water circuit piping **MUST** be insulated to prevent condensation during operation in cooling mode and reduction of the cooling and heating capacity, as well as to prevent freezing of outside pipes during winter. The minimum insulation thickness of the pipes should be 19 mm (0.039 W/mK), preferably comprising a closed cell insulation or a vapour barrier. In outdoor areas exposed to the sun, the insulation must be protected from the effects of degradation.
- We recommend inserting cut-off valves between the installation piping and the heat pump to simplify maintenance tasks.
- Leave a free space around the heat pump for carrying out any maintenance and repair operations (see "*Location*").
- Air vent valves and suitable devices should be fitted for the correct removal of air from the circuit during the filling stage.
- Install all the necessary safety elements (expansion vessel, safety valve, etc.) to comply with the applicable regulations for the installation.
- A **water filter** must be installed in the water circuit of the heat pump, in order to avoid obstructions or narrowing caused by dirt in the installation. The filter **MUST** be installed before filling the installation with water and in the return branch of the machine, to avoid the entry of dirty water into the heat exchanger (condenser). The type of filter installed must be adapted to the particular characteristics of each installation (type and material of the water pipes, type of water used, water volume of the installation, etc.). The water filter should be checked and cleaned, if necessary, at least once a year. In new installations, however, it is advisable to check it within the first few months of its commissioning.
- For the correct operation of the heat pump, a minimum water volume must be ensured in the installation, as well as a minimum flow in the hydraulic circuit of the machine. If the minimum circulation flow is not reached by the heat pump, it will be blocked, and an alarm code will be displayed on the main board display. According to the **DUAL CLIMA** model installed, these values will be:

	<b>DUAL CLIMA 8</b>	<b>DUAL CLIMA 11</b>	<b>DUAL CLIMA 16</b>
<b>Minimum volume (l)</b>	40	60	80
<b>Minimum flow rate (l/min)</b>	10	15	20

If the water volume of the installation is lower than this value, install an inertia tank in the heating/cooling circuit. To avoid condensation and premature deterioration of the inertia tank, make sure that all hydraulic fittings and connections are properly insulated, especially when the tank is to be used in Cooling mode.

- In multi-zone installations managed by thermostatic or similar valves, some method must be provided to maintain the minimum flow rates indicated above, even when all zones are closed (bypass valve, etc.).

### 9.5.1 Installing a DHW tank

The **DUAL CLIMA** heat pump may include (optionally) in its installation a tank for the production of domestic hot water. In the offering of aerothermal accessories, **DOMUSA TEKNIK** offers a wide range of DHW tanks specially designed to be combined with the **DUAL CLIMA** heat pumps (**Sanit HE**, **BT-Trio** and **BT-Duo HE** lines). The hydraulic installation of the tank must be made by qualified personnel, subject to the applicable installation legislation and the attached instructions of the tank.

To combine an DHW tank with the heat pump, insert the **DHW tank sensor** supplied with it into the tank sensor housing. In addition, a 3-way diverter valve (**G1**) must be installed between the external machine and the DHW + heating/cooling installation, by means of what, the electronic controller diverts the water from the heat pump to the DHW production or to the Heating/Cooling installation, depending on whether there is demand for DHW.

**Dc:** Dual Clima heat pump.

**Ac:** Sanit HE tank.

**Sa:** DHW tank sensor.

**G1:** 3-way diverter valve.

**E1:** DHW backup resistor.

**Ic:** Heating/Cooling installation.

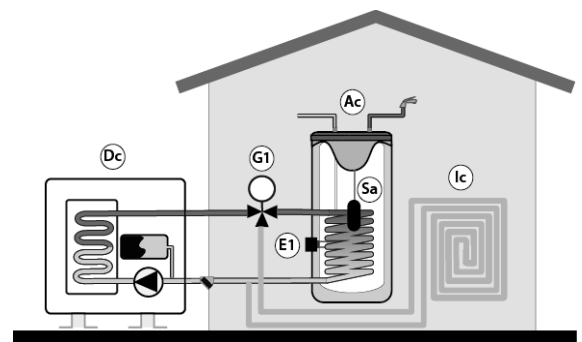

In addition, optionally, a backup heater (**E1**) can be installed, by means of what DHW temperatures higher than 50 °C can be obtained.

As alternative to the backup heater, **Dual Clima** heat pump optionally allows the connection of a conventional source of energy (as a gas boiler, oil boiler, etc.) as backup for DHW production, by means of the same electrical connection **E1**. For it, the DHW tank must be provided with an auxiliary coil exchanger and/or any intermediate system of exchange that allows the hydraulic connection of the above mentioned backup source of energy. Within the range of accessories for heat pumps, **DOMUSA TEKNIK** offers the range of DHW tanks **Sanit HE DS**, which incorporate an auxiliary coil exchanger specially designed to be combined with **DUAL CLIMA** heat pumps.

**Dc:** Dual Clima heat pump.

**Ac:** Sanit HE DS tank.

**Sa:** DHW tank Sensor.

**G1:** Diverter 3 way valve.

**E1:** DOMUSA's backup boiler.

**Ic:** Heating/Cooling installation.

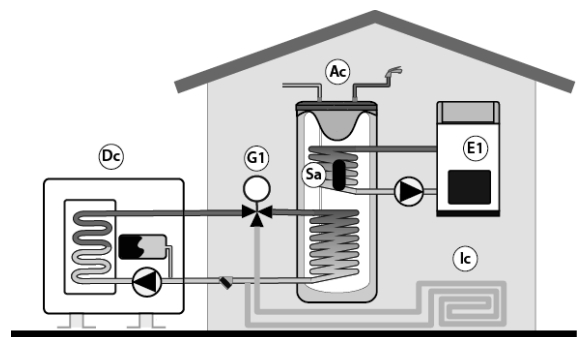

To perform the electrical installation of the DHW tank sensor, the 3-way valve (**G1**), and the backup heater or boiler (**E1**), read the "*Electrical Connections*" section of this manual carefully.

# DUAL CLIMA

## 9.5.2 Filling the installation

The hydraulic installation must include a filling valve, air vent valves and the necessary hydraulic components for correctly filling it.

To fill the heat pump, open the filling valve until the pressure gauge located on the back of the machine shows a pressure of 1~1.5 bars. The heat pump has a manual air vent on top of the heat exchanger's (condenser) flow tube. Open it during the filling process and wait for the water to begin flowing out. The air should also be bled from the rest of the installation using the air vent valves provided. Filling should be performed slowly, thus helping the evacuation of air from the water circuit. Close the filling valve after filling. To comfortably access the heat pump air vent valve, open the top cover and side panel of the heat pump.

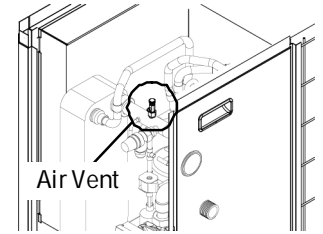

**IMPORTANT: Switching on the heat pump with no water inside could result in serious damages.**

## 9.5.3 Draining the heat pump

With the **DUAL CLIMA** heat pump, a drain valve is supplied, which must be installed in the outlet provided in the bottom part of the back side of the machine. The draining of the heat pump water will be carried out by opening said valve. Connect a flexible hose to the valve and run it to a drain. To ensure a complete drainage, it is advisable to open the manual air vent that incorporates the heat pump in its interior, so that the air enters the circuit. After draining the boiler, close the drain valve again and remove the flexible tube.

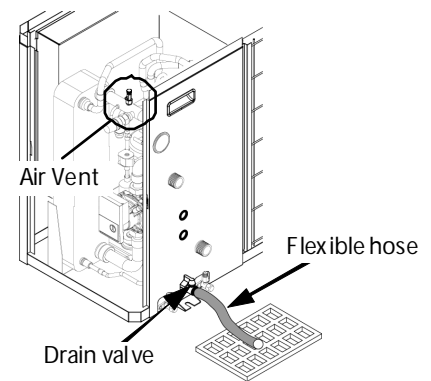

## 9.6 Electrical connections

The electrical installation of the **DUAL CLIMA** heat pump and its electrical accessories should be carried out by qualified personnel, subject to the current installation regulations on the matter. The electrical installation must be connected so that the heat pump can be fully isolated and disconnected for the safe execution of any maintenance operations.

The machine has 2 holes with cable grommets in its back side to introduce all connection cables inside the machine. The cables exposed to the weather conditions of the exterior should be protected by means of protective raceways or pipes. Alternatively, they should be of a suitable category for use outdoors (H07RN-F type or higher). It is also advisable to keep the high-voltage cables (general supply, diverter valves, electrical heaters, circulation pumps, etc.) at a minimum distance of 25 mm from low-voltage cables (main board cable, temperature sensors, room sensor, etc.) and drive them through independent pipes.

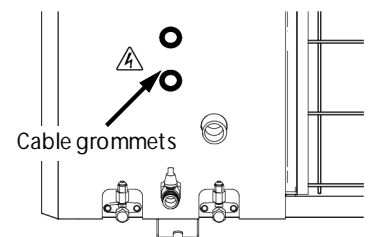

**IMPORTANT: Before carrying out any work on the electrical installation of the heat pump, always ensure it is disconnected from the mains.**



### 9.6.1 Connection to the main power supply

The **DUAL CLIMA** heat pump is prepared for connection to 230 V~ 50 Hz in the terminals indicated in the figure (see "*Electrical Diagrams*"). Inside the machine, open the front door and access to the electronic boards area to find the power supply terminals. **Make sure to make the earth connection.**

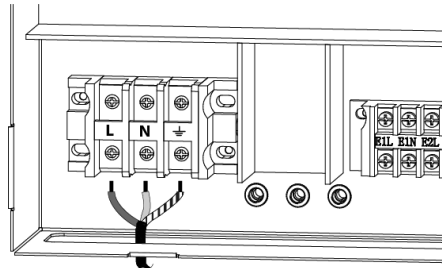

The dimensioning and type of the main supply cables must at all times comply with the rules and regulations in force. Nevertheless, the following table details some recommended features and dimensions, as a guide:

	DUAL CLIMA 8			DUAL CLIMA 11			DUAL CLIMA 16		
	HP	HP+E1	HP+E1+E2	HP	HP+E1	HP+E1+E2	HP	HP+E1	HP+E1+E2
<b>Maximum consumption (A)</b>	12.5	32.5	52.5	15	35	55	25	45	65
<b>Min. wire section (mm<sup>2</sup>)</b>	1.5	4	10	1.5	6	10	2.5	10	10
<b>Recommended fuse</b>	16 A	36 A	63 A	25 A	40 A	63 A	32 A	50 A	75 A
<b>Recommended cable type</b>	H05VV-U3G (protected in pipe)								

**HP:** Heating Pump. **E1:** DHW auxiliary electrical heater. **E2:** Heating auxiliary electrical heater.

For the correct selection of the type and dimensions of machine's main supply cable, it has to take in account the electrical consumption of the optional accessories connected on the heat pump (auxiliary electrical heaters, circulating pumps, ...). There are columns included in the above table indicating the maximum consumptions for combinations of heat pump and the auxiliary heater **E1** and **E2** (see "*Electrical Diagrams*").

The electrical connection of the heat pump must be protected by an earth leakage circuit breaker (a high-speed switch of 30 mA (<0.1 s)).

**IMPORTANT: Before carrying out any work on the electrical installation of the heat pump, always ensure it is disconnected from the mains.**

# DUAL CLIMA

## 9.6.2 Main board connection

The main board is supplied inside the heat pump. Before start-up, it must be connected to the machine. To do this, first install the main board inside the house and pass the cable that is supplied to this location (located near the sensor bundle). Finally, the connectors of the cable and the main board should be connected at their ends.

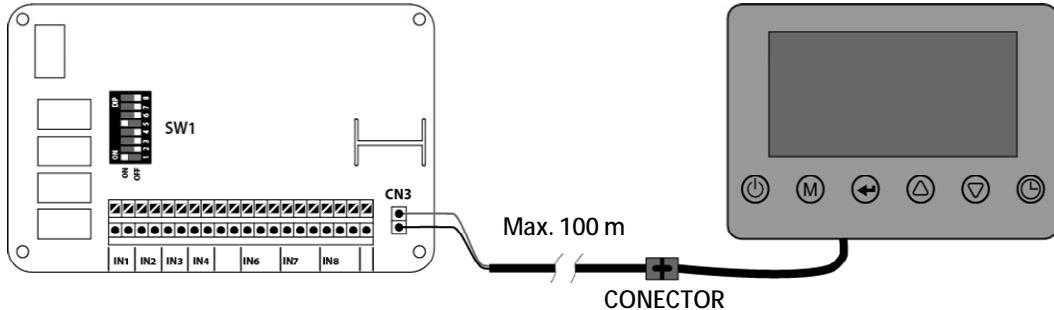

The cable supplied with the heat pump is 5 meters long. If necessary, it can be extended to a maximum distance of 100 meters (section between 0.5 ÷ 1.25 mm<sup>2</sup>).

**IMPORTANT: Before carrying out any work on the electrical installation of the heat pump, always ensure it is disconnected from the mains.**

## 9.6.3 Connecting the DHW tank sensor

When installing an DHW tank in combination with the heat pump, a temperature sensor must be installed in the accumulator. By means of this sensor, the electronic controller of the heat pump will be able to manage the temperature of the DHW, activating the DHW mode when the temperature of the accumulator falls below the desired temperature.

The DHW tank sensor is supplied within the **DUAL CLIMA** heat pump. This sensor is located inside the machine (in a sensor bundle). To install it, release the sensor from the bundle, take it to where the DHW tank is located, and insert it into the sensor housing provided in it.

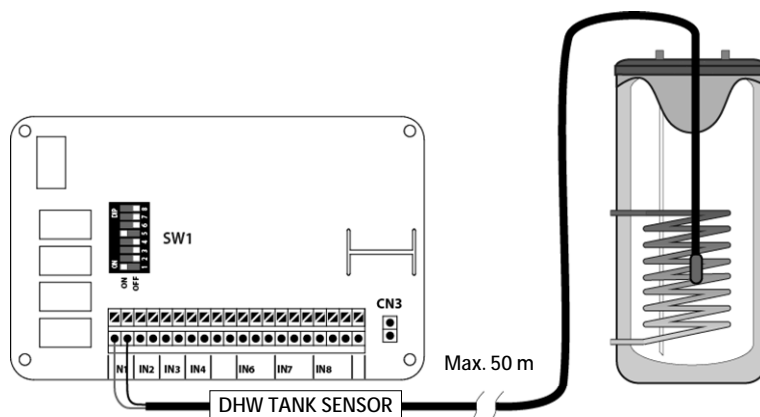

The sensor supplied with the heat pump is 5 meters long. If necessary, it can be extended to a maximum distance of 50 meters (section between 0.5 ÷ 1.25 mm<sup>2</sup>).

**IMPORTANT: Before carrying out any work on the electrical installation of the heat pump, always ensure it is disconnected from the mains.**

### 9.6.4 Connecting a backup source of energy for DHW (E1)

The **DUAL CLIMA** heat pump allows the connection of an electrical heater for DHW production backup (optional). It should be mounted in the socket provided for this purpose in the tank. With this heater, it will be possible to obtain hot water temperature exceeding 50 °C, enabling the necessary temperature to be reached for the correct execution of the function for protection against the Legionella bacteria.

The electrical connection of the resistor will be made between terminals **E1L** and **E1N** (Neutral) of the component terminal of the heat pump.

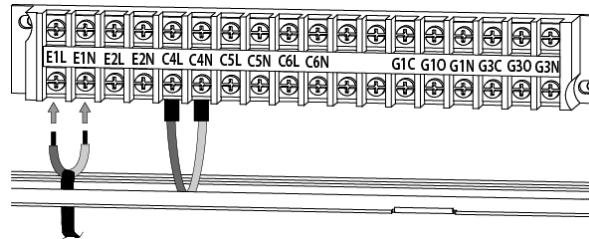

The relay that activates the heater has a maximum capacity of 20 A of consumption. Therefore, to connect resistors exceeding 4,500 W, a contactor must be interposed between the terminals of the power terminal and the heater.

As alternative to the backup electrical heater, **Dual Clima** heat pump allows the connection of a conventional source of energy as gas boiler, oil boiler, biomass, etc. For it, the DHW tank must be provided with an auxiliary coil exchanger and/or any intermediate system of exchange that allows the hydraulic connection of the above mentioned backup source of energy.

They are used the same terminals **E1L** and **E1N** (Neutral) of the components powerstrip to make the connection between the backup source of energy and the heat pump. Depending on the installation characteristics and the type of the backup boiler, the electrical connection could be made at least by 2 different ways:

#### Direct connection

In this type of connection it is used the powered output of **E1** relay (230 V~; maximum 20A) to activate directly the backup energy source (switch on the boiler, activate the backup circulating pump, etc.). For it, connect the terminals **E1L** and **E1N** of the heat pump to the main power input of the backup boiler and/or of the device of the installation provided.

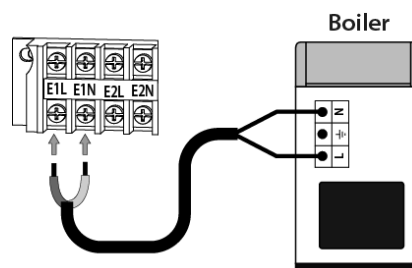

**NOTE:** When the backup source of energy is connected, it has to be taken in account that the maximum capacity of E1 relay is 20 A.

# DUAL CLIMA

## Voltage-free connection

When the input to manage the activation of the backup energy source is voltage-free type (i.e. room thermostat input, phone relay input, etc.), it is necessary to isolate the powered output of the heat pump (E1) from the voltage-free input of the backup energy source, by means of installing a relay between them. To perform correctly this electrical installation follow carefully the diagram below:

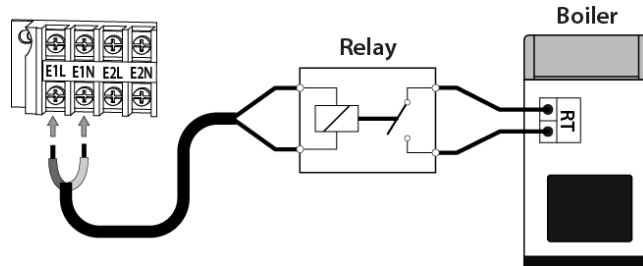

**IMPORTANT:** Before carrying out any work on the electrical installation of the heat pump, always ensure it is disconnected from the mains.

### 9.6.5 Connecting the DHW diverter valve (G1)

When installing an DHW tank in combination with the heat pump, a motorised 3-way diverter valve must be installed between the unit and the installation. By means of this valve, the electronic controller of the heat pump will divert the water to the DHW tank (in DHW mode) or to the heating/cooling circuit (in heating or cooling mode).

The electrical connection of the valve will be made in terminals **G1C**, **G1O** and **G1N** (Neutral) of the component terminal of the heat pump. The motorised diverter valve can be equipped with 2 wires (with return spring) or 3 wires. If the valve is equipped with 2 wires, depending on its hydraulic assembly, it must be connected in some terminals or others. The following figures describe the connection of each type of motorised valve:

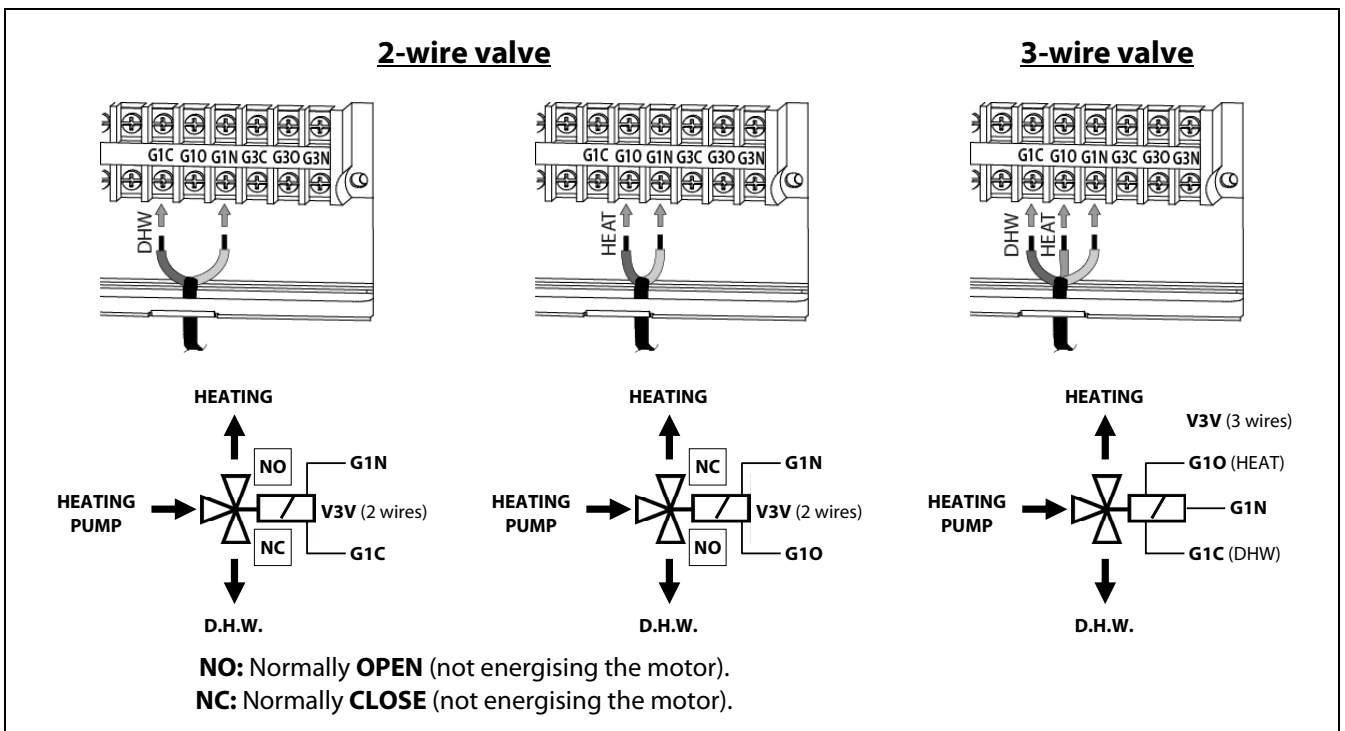

**IMPORTANT:** Before carrying out any work on the electrical installation of the heat pump, always ensure it is disconnected from the mains.

### 9.6.6 Connecting a backup source of energy for Heating installation (E2)

The **DUAL CLIMA** heat pump allows the connection of a backup electrical heater for Heating installation (optional). Within the wide range of accessories for heat pumps, **DOMUSA TEKNIK** offers the optional HP Hydraulic Kit that includes a heating electrical heater (2,500 W).

The electrical connection of the heater will be made between terminals **E2L** and **E2N** (Neutral) of the component terminal of the heat pump.

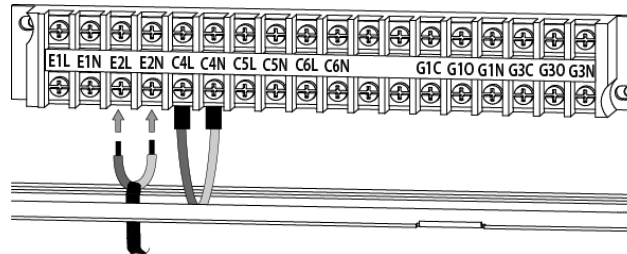

The relay that activates the electrical heater has a maximum capacity of 20 A of consumption. Therefore, to connect a heater exceeding 4,500 kW, a contactor must be interposed between the terminals of the power terminal and the heater.

As alternative to the backup electrical heater, **Dual Clima** heat pump allows the connection of a conventional source of energy as gas boiler, oil boiler, biomass, etc. For it, the heating installation must be provided with an auxiliary system of water heat exchange that allows the hydraulic connection of the above mentioned backup source of energy, preferably it should be independent from the water circuit of the heat pump.

They are used the same terminals **E2L** and **E2N** (Neutral) of the components powerstrip to make the connection between the backup source of energy and the heat pump. Depending on the installation characteristics and the type of the backup boiler, the electrical connection could be made at least by 2 different ways:

#### Direct connection

In this type of connection it is used the powered output of **E2** relay (230 V~; maximum 20A) to activate directly the backup energy source (switch on the boiler, activate the backup circulating pump, etc.). For it, connect the terminals **E2L** and **E2N** of the heat pump to the main power supply input of the backup boiler and/or of the device of the installation provided.

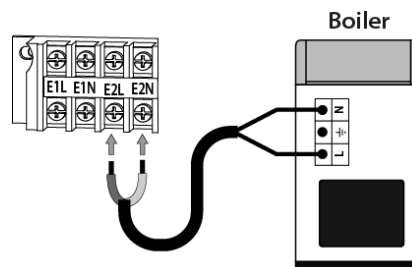

**NOTE:** When the backup source of energy is connected, it has to be taken in account that the maximum capacity of E2 relay is 20 A.

# DUAL CLIMA

## Voltage-free connection

When the input to manage the activation of the backup energy source is voltage-free type (i.e. room thermostat input, phone relay input, etc.), it is necessary to isolate the powered output of the heat pump (E2) from the voltage-free input of the backup energy source, by means of installing a relay between them. To perform correctly this electrical installation follow carefully the diagram below:

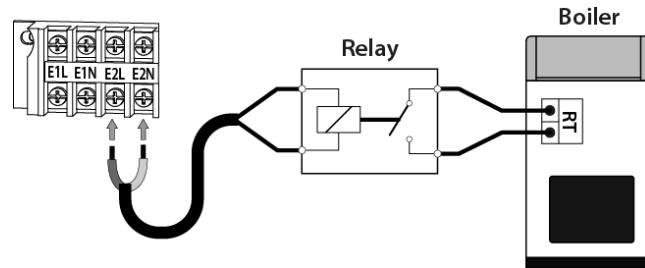

**IMPORTANT:** Before carrying out any work on the electrical installation of the heat pump, always ensure it is disconnected from the mains.

### 9.6.7 Connecting the Heat/Cold diverter valve (G3)

When it is required to divert the water to different circuits depending on whether the machine is in the Heating or Cooling mode (e.g. Heating by radiators and Cooling by fan-coils), a motorised 3-way diverter valve must be installed between the machine and the installation. By means of this valve, the electronic controller of the heat pump will divert the water to the heating circuit during Heating mode or to the cooling circuit during the Cooling mode.

The electrical connection of the valve will be made between terminals **G3C**, **G30** and **G3N** (Neutral) of the component terminal of the heat pump. The motorised diverter valve can be equipped with 2 wires (with return spring) or 3 wires. If the valve is equipped with 2 wires, depending on its hydraulic assembly, it must be connected in some terminals or others of said terminal. The following figures describe the connection of each type of motorised valve:

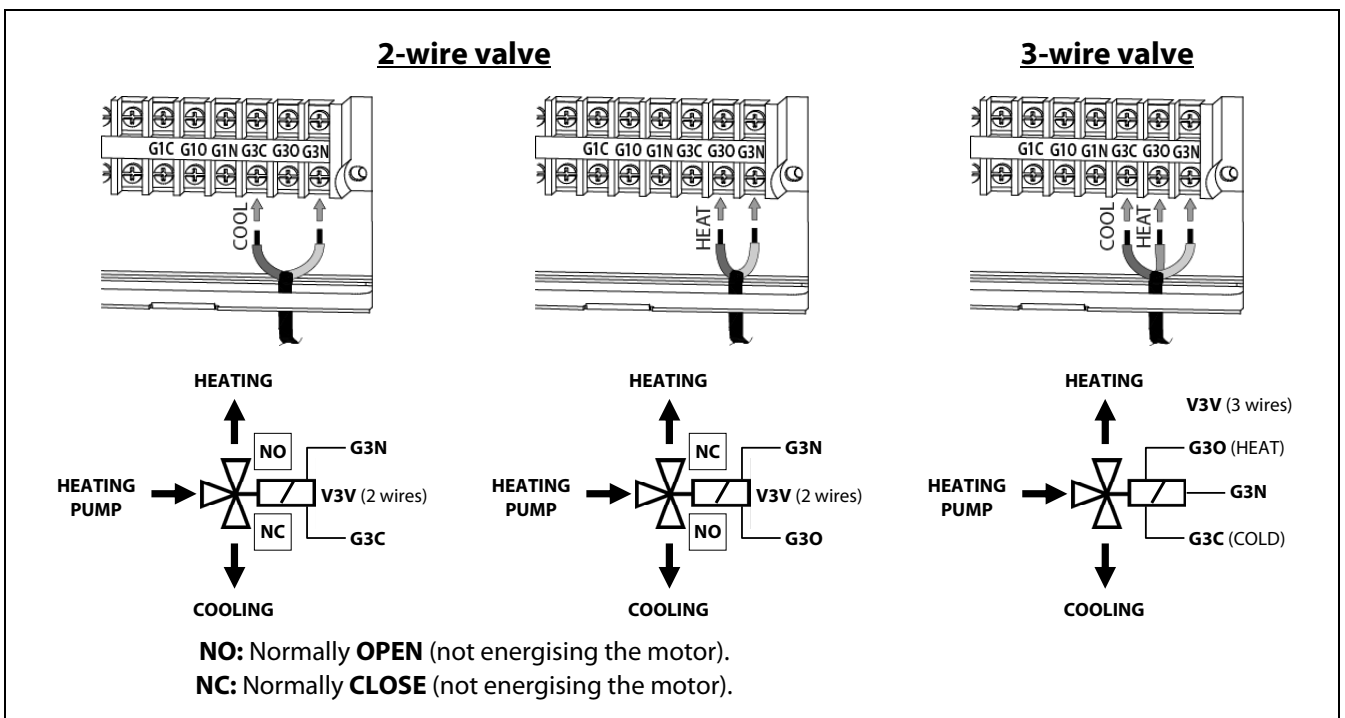

**IMPORTANT:** Before carrying out any work on the electrical installation of the heat pump, always ensure it is disconnected from the mains.

### 9.6.8 Connecting the installation pump (C5)

The **DUAL CLIMA** heat pump allows the connection of a circulation pump (**C5**) for the Heating/Cooling installation, whose operation will be managed by a room sensor (**IN6**) connected to the machine (see "Connecting a Room Sensor").

The electrical connection of the pump will be made between terminals **C5L** and **C5N** (Neutral) of the component terminal of the heat pump.

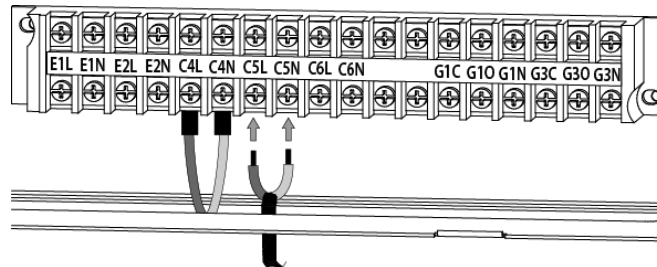

**IMPORTANT:** Before carrying out any work on the electrical installation of the heat pump, always ensure it is disconnected from the mains.

### 9.6.9 Connecting a Heat Pump auxiliary pump (C6)

The **DUAL CLIMA** heat pump allows the connection of a circulation pump (**C6**) to increase the water flow rate of the machine if necessary, in addition to that obtained by its internal pump (**C4**). This **C6** circulation pump will work in parallel with the internal pump of the **C4** machine only when it is operating in the Heating or Cooling mode.

The electrical connection of the resistor will be made between terminals **C6L** and **C6N** (Neutral) of the component terminal of the heat pump.

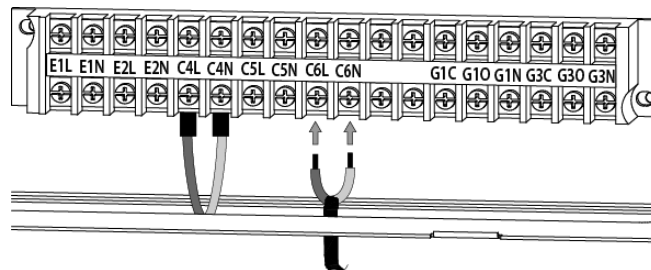

**IMPORTANT:** Before carrying out any work on the electrical installation of the heat pump, always ensure it is disconnected from the mains.

# DUAL CLIMA

## 9.6.10 Connecting the room thermostat

The **DUAL CLIMA** heat pump incorporates an **IN7** connection in the input terminal (located on the electronic controller board) prepared for the connection of a room chrono-thermostat or room thermostat (see "Electrical Diagrams"), which will stop the heating and/or cooling service of the heating/cooling installation, turning off the operation of the heat pump when the desired temperature in the home is reached. The operation with the room thermostat will not affect the DHW service, keeping it enabled regardless of the status of the thermostat.

The IN7 terminals are supplied from the factory with a jumper between them, so it will be necessary to remove the jumper before connecting the room thermostat. To disconnect the jumper and connect the thermostat, press the upper screws with a thin flat screwdriver to release the cables and stop pressing to reattach them.

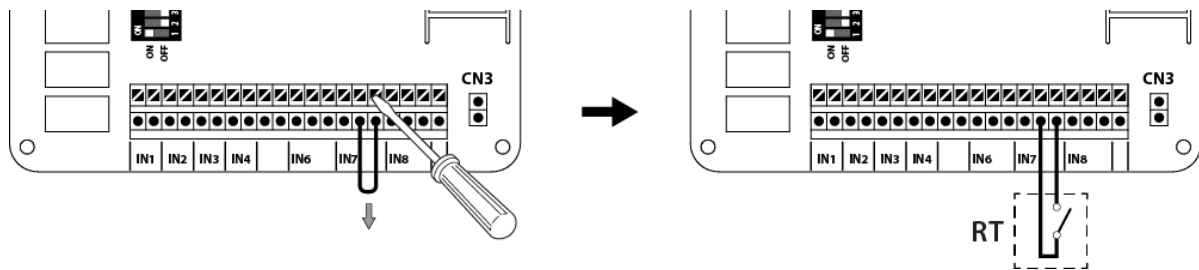

**IMPORTANT:** Before carrying out any work on the electrical installation of the heat pump, always ensure it is disconnected from the mains.

**IMPORTANT:** AUTO mode is incompatible to work together with a room thermostat, so it is not recommended to select this mode if there is any installed.

## 9.6.11 Connecting the room sensor

The **DUAL CLIMA** heat pump incorporates an **IN6** connection in the input terminal (located on the electronic controller board) prepared for the connection of a room temperature sensor to measure the temperature inside the home (see "Electrical Diagrams"), which will allow the circulation pump of the heating/cooling installation (**C5**) to be stopped when the desired temperature in the home is reached, no longer delivering heat or cold to the room. The heat pump will remain activated until it reaches the setpoint temperature selected for it (see "Temperature Selection"). The operation with the room sensor will not affect the DHW service (if any), keeping it enabled regardless of the temperature inside the home.

The IN6 terminals are supplied from the factory with an electronic resistor between them, so it will be necessary to remove it before connecting the room sensor. To disconnect the resistor and connect the sensor, press the upper screws with a thin flat screwdriver to release the cables and stop pressing to reattach them.

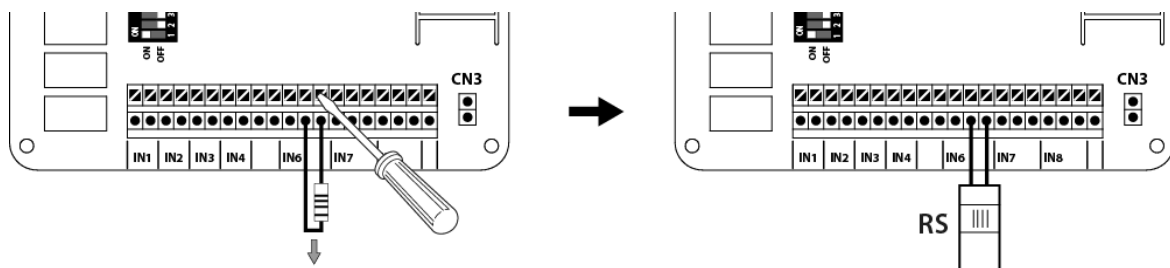

**IMPORTANT:** Before carrying out any work on the electrical installation of the heat pump, always ensure it is disconnected from the mains.



## 9.7 Freeze Protection

The **DUAL CLIMA** heat pump is a machine that is installed in the exterior of the home, so that it will be exposed to the extreme climatic conditions of cold in the periods of frost. Because of this, it is of paramount importance that this type of machine is protected against such frost, as its internal construction and the amount of water inside it make it more prone to freezing. The freezing of the water inside the heat pump causes the rupture of the heat exchanger, with the subsequent interruption of its operation and major economic expenses involving its repair.

For these reasons, it will be **mandatory** to use a safety system in the installation to prevent the freezing of water in the machines. **DOMUSA TEKNIK** proposes the use of any of the following systems:

- **Antifreeze liquid (glycol):** The antifreeze liquid must be diluted with the water inside the heat pump. The concentration of glycol in the mixture must be calculated taking into account the historical minimum temperature of the climatic zone where the machine is located and the concentrations indicated by the manufacturer of the glycol for said minimum temperature. Additionally, it will be essential to perform a periodic analysis of the water-glycol mixture to ensure that the proper properties and mixing percentage are maintained over time (at least once a year).
- **Antifreeze valve of the exteriors:** The antifreeze valve or valves should be installed outside the building, in the water circuit of the heat pump, near the heat pump, if possible. It **should be ensured** that, when activated, the entire water content in the interior of the machine is drained. Due to the construction of the **DUAL CLIMA** heat pump, to drain the water content, at least one antifreeze should must be installed in the water drain pipe (between the machine and the drain valve). **DOMUSA TEKNIK** optionally offers an antifreeze valve kit especially designed to be installed in the **DUAL CLIMA** heat pump.

In addition to these active systems for antifreeze safety, a water filter must be installed in the water circuit of the heat pump, in order to avoid obstructions or narrowing caused by dirt in the installation to help accelerate the freezing process or to cause the water drainage devices not to work properly. The filter must be installed before filling the installation with water and in the return branch of the machine, to avoid the entry of dirty water into the heat exchanger. The type of filter installed must be adapted to the particular characteristics of each installation (type and material of the water pipes, type of water used, water volume of the installation, etc.). The water filter should be checked and cleaned, if necessary, at least once a year. IN new installations, however, it is advisable to check it within the first few months of its commissioning.

**DOMUSA TEKNIK will not cover damages caused by the lack of any of these antifreeze safety systems described above.**

In installations where glycol has not been added, in case of prolonged periods of absence, to prevent possible accidental power failures and/or heat pump failure, the water in the machine must be drained. In periods of frost, the absence of electricity for 30 minutes or more may cause the water to freeze.

The electronic controller of the **DUAL CLIMA** heat pump has a function for protection against the freezing of the water in its interior in periods of frost. For this function to remain active and on alert, the heat pump must be connected to the mains and have a power supply, even if it is switched off or not in use.

## DUAL CLIMA

The antifreeze function will activate the operation of the circulation pumps, compressor and other installation components depending on the temperature conditions being read, both in the water and outside the home. The following sections describe the operation of the antifreeze process of the **DUAL CLIMA** heat pump.

### 9.7.1 Antifreeze in DHW mode

When the temperature of the Domestic Hot Water tank falls below +5 °C, the controller starts the antifreeze function, activating the DHW mode. When the temperature of the tank reaches 20 °C, the function stops. If the heat pump stays on for more than 30 minutes without reaching the indicated temperature, the antifreeze function of the DHW will stop.

### 9.7.2 Antifreeze in Heating mode

When the water temperature of the heat pump drops below +4 °C (read on the flow or on the return), the controller starts the antifreeze function, activating the water circulation pumps (**C4** and **C6**). If the outside temperature is below 15 °C, the operation of the heat pump will also be activated. When the water temperature reaches 10 °C or the heat pump has been running for more than 30 minutes without reaching this temperature, the antifreeze function will stop. If, when the antifreeze function is enabled, the water temperature drops by 1 °C or more, the heat pump will stop and an error code will be displayed on the screen.

**IMPORTANT: It will be mandatory to use a safety system in the installation to prevent the freezing of water in the machines.**

**DOMUSA TEKNIK will not cover damages caused by the lack of an antifreeze safety system in the installation.**

**NOTE: For the antifreeze function to remain active and on alert, the heat pump must be connected to the mains and have electrical supply.**

## 10 CONFIGURING THE HEAT PUMP

The **DUAL CLIMA** heat pump is supplied from factory configured to provide Heating, Cooling and DHW modes. In case the installation does not have any of these services allowed, **they must be disabled** by adjusting the DIP-Switch (**SW1**) of the control PCB (see "Electrical Diagrams"). When any mode is disabled, all the settings and parameters related to this operating mode will disappear from the main board display.

Before accessing and adjusting the DIP-Switch **disconnect** the main power supply of the heat pump. To access the DIP-Switch, remove the front door of the machine and remove the cover of the electronic boards.

### Disabling the DHW mode

If the installation does not have an storage tank for the production of DHW, this mode must be disabled. To do this, set the switch **SW1-6** to ON.

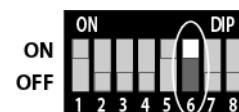

### Disabling the Heating mode

If the installation does not have a water circuit ready to operate in heating mode (underfloor heating, radiators, etc.), this mode must be disabled. To do this, set the switch **SW1-7** to ON.

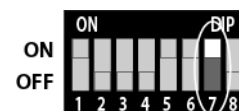

### Disabling the Cooling mode

If the installation does not have a water circuit ready to operate in the cooling mode (cooling floor, fan coils, etc.), this mode must be disabled. To do this, set the switch **SW1-8** to ON.



**IMPORTANT: Keeping a mode enabled without the installation being prepared to operate with it may cause a malfunction of the heat pump and SERIOUS damage to the installation.**

## 11 TECHNICAL MENU

The electronic controller of the **DUAL CLIMA** pump has a menu of technical parameters, with which the operation of the pump is managed in the gas and water circuits. Any incorrect adjustment of any of these may cause a breakdown and/or rupture of the machine. Therefore, most parameters of the technical menu should only be modified by personnel authorised by **DOMUSA TEKNIK**. Nevertheless, some technical parameters (described in previous sections) will be useful for the installer and/or the user and should be adjusted by them, depending on the thermal characteristics and performance desired in the home.

To access the technical menu parameters, keep buttons **(M) + (△)** pressed simultaneously for 3 seconds (until you hear a beep). The display will show the first parameter **P00** along with its current value. Use buttons **(△) (▽)** to select the desired parameter and press **(←)** to access its current value. The display will show only the value flashing. Use buttons **(△) (▽)** to select the desired value and press **(←)** to confirm and return to the technical menu. After finishing the parameter adjustment, press **(⏻)** to exit the Technical menu.

## DUAL CLIMA

The following is a list of parameters that can be adjusted by the installer and/or user. Any adjustment of a parameter that is not in this list may cause a serious breakdown and/or rupture of the heat pump. Therefore, **DOMUSA TEKNIK** will not be held responsible for damages caused by their incorrect modification by unauthorised personnel.

Code	Definition	Range	Default value
P09	Outside temperature to activate the backup energy source for DHW ( <b>E1</b> ).	-20 ~ 20 °C	0 °C
P10	Outside temperature to activate the backup energy source for heating ( <b>E2</b> ).	-20 ~ 20 °C	0 °C
P27	Functioning mode of the backup energy sources ( <b>E1, E2</b> )	0: Backup mode 1: Auxiliary mode	0
P28	Outside temperature to activate the backup energy source for heating in auxiliary mode ( <b>E2</b> ).	-30 ~ 10 °C	-15 °C
P29	Room temperature setpoint. (Only with room sensor installed)	10-28°C	21 °C
P45	AU curve offset value. (Only with AU mode selected)	-15-15°C	0 °C
P46	Maximum AU curve temperature value. (Only with AU mode selected)	30-50°C	45 °C
P47	Night mode activation.	0 (disabled), 1 (enabled)	1
P48	Start time of the Night mode.	0-23 (hour)	22
P49	Shutdown time of the Night mode.	0-23 (hour)	6

### 12 BACKUP SOURCES OF ENERGY SET UP (E1, E2)

The basic principle of **Dual Clima** heat pump functioning consists of getting the energy from the air outside the building and using it inside the house in the form of thermal energy for a heating/cooling water circuit and/or to produce Domestic Hot Water. For this reason, the capacity of heating of the heat pump will depend directly on the quantity of available energy in the air outside the building, and in consequence, on the temperature and humidity of it.

For these reasons, when the weather conditions where the heat pump is located are of extremely low temperatures and/or wet, the heat pump could need the help of a backup source of energy to reach the wished conditions of comfort. **Dual Clima** heat pump includes 2 relay outputs (**E1, E2**) for the connection of mentioned backup energy sources, which might be electrical heaters, gas boiler, oil boiler, etc., or any combination of them. One of these outputs is dedicated to help in DHW production (**E1**), whereas the other one is dedicated to help in heating circuit requirements (**E2**).

The way of functioning of these outputs related to the outside temperature could be set by means of **P27** parameter of the Technical, being able to be selected 2 different functioning modes.



## 12.1 Backup source mode (P27 = 0)

In this mode the energy sources will be activated when the outside temperature descends from a value selected in the parameters **P09** and **P10** of the Technical menu, in order to help the heat pump to achieve its requirements, keeping both systems working together in combination. This is the mode set by default.

The backup energy source for DHW (**E1**) will be only activated when the heat pump is working in DHW production mode and the backup energy source for Heating (**E2**) will be only activated when it is working in Heating mode.



### **Backup mode setup for DHW (E1)**

When the heat pump is working in DHW mode, the backup energy source connected to **E1** output will be enabled if outside temperature descends from the value selected in the parameter **P09** and if the heat pump cannot achieve the DHW temperature setpoint adjusted. Once the backup source of energy of support is activated, the heat pump and the backup energy will work together to reach the desired DHW temperature.

The range of values for **P09** parameter is between -20 ~ +20 °C. The default value set in factory is 0 °C and, once the **P09** parameter is selected within the Technical menu, it can be increased or decreased by means of using the buttons   respectively (see "Technical Menu"). Once the desired value is adjusted, press the button  to save it.

### **Backup mode setup for Heating (E2)**



When the heat pump is working in Heating mode, the backup energy source connected to **E2** output will be enabled if outside temperature descends from the value selected in the parameter **P10** and if the heat pump cannot achieve the Heating temperature setpoint adjusted. Once the backup source of energy of support is activated, the heat pump and the backup energy will work together to reach the desired Heating temperature.

The range of values for **P10** parameter is between -20 ~ +20 °C. The default value set in factory is 0 °C and, once the **P10** parameter is selected within the Technical menu, it can be increased or decreased by means of using the buttons   respectively (see "Technical Menu"). Once the desired value is adjusted, press the button  to save it.

## 12.2 Auxiliary source mode (P27 = 1)

In this functioning mode the Heating backup source of energy (**E2**) becomes an alternative source of energy to the one of the heat pump ("auxiliary source"). It is activated when the outside temperature descends from the value selected in the parameters **P28** of the Technical menu. At the same time, the heat pump is switched off (Stand By mode), remaining the auxiliary source **E2** as the unique heat source for the whole installation, for Heating and DHW mode.

In this functioning mode the backup energy source for DHW (**E1**) is only activated when it is necessary to achieve a temperature higher than 50 °C in the DHW tank.

The range of values for **P28** parameter is between -30 ~ +10 °C. The default value set is -15 °C and, once the **P28** parameter is selected within the Technical menu, it can be increased or decreased by means of using the buttons   respectively (see "Technical Menu"). Once the desired value is adjusted, press the button  to save it.

### 13.1 Prior warnings

Repair and maintenance of the heat pump must be carried out by a qualified professional authorised by **DOMUSA TEKNIK**. For optimal operation and conservation of the heat pump, it should be serviced annually.

Carefully read this instruction manual and keep it in a safe, easily-accessible place. **DOMUSA TEKNIK** will not be liable for any damages caused by failure to follow these instructions.

Before any servicing, disconnect the heat pump from the mains.

### 13.2 Start-up

In order for the guarantee to be valid, the heat pump must be started up by personnel authorised by **DOMUSA TEKNIK**. Before beginning the start-up process, the following must be complied with:

- The heat pump must be electrically connected to the mains and the power supply should be correct.
- The installation must be filled with water (the pressure must be between 1 and 1.5 bar) and well flushed.
- If the installation has flow and return valves, check they are open.

The start-up sequence, as minimum, should be as follows:

- Check that the configuration of the heat pump is correct and corresponds to the Heating, Cooling and/or DHW services allowed for the installation.
- Check that the values of all the parameters (**P**) of the Technical menu are correct and adjust them if necessary.
- Check that the heat pump and the internal piping installation do not present any damage caused during transport.
- Check that the fan can move freely.
- Check that the insulation of all pipes is correct, particularly in installations that can be used in Cooling mode.

### 13.3 Equipment delivery

After the initial start-up, the Technical Assistance Service will explain to the user how the heat pump functions, making any observations they consider relevant.

The installer is responsible for clearly explaining to the user the functioning of any control or regulation device forming part of the installation but not supplied with the heat pump.

## 14 MAINTENANCE

To maintain the heat pump in perfect working order, a yearly maintenance should be performed by personnel authorised by **DOMUSA TEKNIK**. Between the maintenance tasks, the following operations should be performed at least once a year:

- Check that the supply, consumption and electrical installation are correct.
- Check that the water installation, safety valves and control devices work correctly.
- Check that the water circulation pump is working correctly. Make sure that the water pipe and pipe fittings do not have leaks and/or clogs.
- Remove all dirt from the evaporator.
- Check that the various components of the gas circuit work correctly. Inspect the joints of the pipes and that the valves are well lubricated.
- Chemically clean the plate heat exchanger every 3 years.
- Check if the coolant gas content is correct.

# DUAL CLIMA

## 15 CIRCULATION PUMP AND PRESSURE DROP DIAGRAMS

By means of the following diagrams it is possible to calculate the hydrodriving pressure available for the heating/cooling installation, taking in account the water pump working curves and the pressure drop of each **Dual Clima** model.

### Circulation pump working curves

In the following diagrams is shown the hydrodriving pressure produced by the water circulation pump of each **Dual Clima** (DC) model, depending on the water flow of the installation:

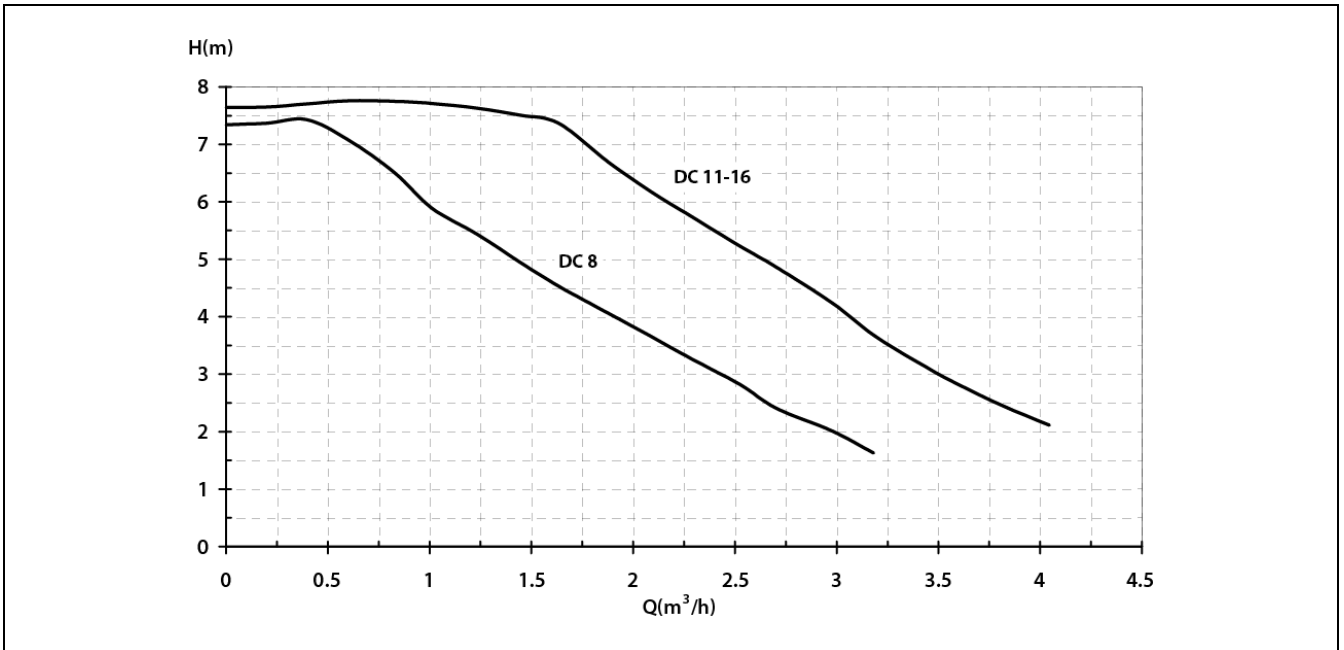

### Heat pump pressure drop curves

In the following diagrams is shown the pressure drop produced by the inner hydraulic circuit of each **Dual Clima** (DC) model, depending on the water flow of the installation:

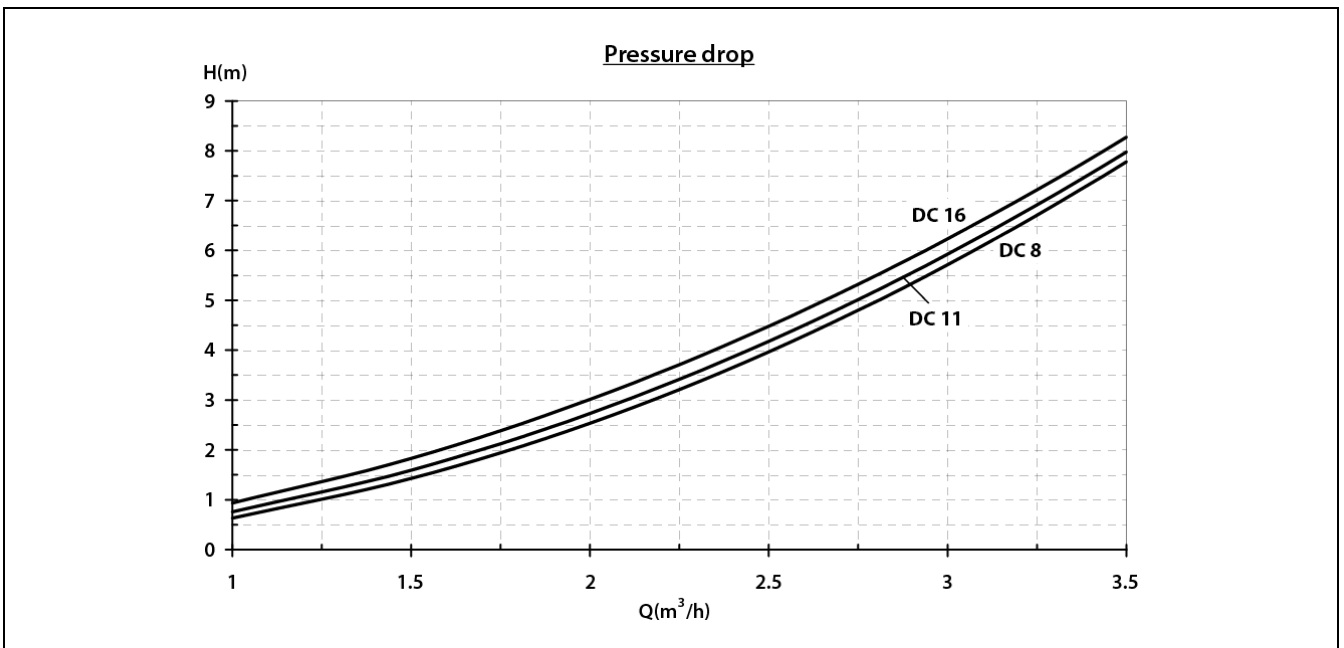



**16 PERFORMANCE AND EFFICIENCY DIAGRAMS**

The basic principle of **Dual Clima** heat pump functioning consists of getting the energy from the air outside the building and using it inside the house in the form of thermal energy for a heating/cooling water circuit and/or to produce Domestic Hot Water. For this reason, the capacity of heating and the efficiency of the heat pump will depend directly on the quantity of available energy in the air outside the building, and in consequence, on the temperature of it.

In the following diagrams the heating performance (output) and efficiency (COP) of each **Dual Clima** model is shown, depending on the outside air temperature.

**Dual Clima 8**

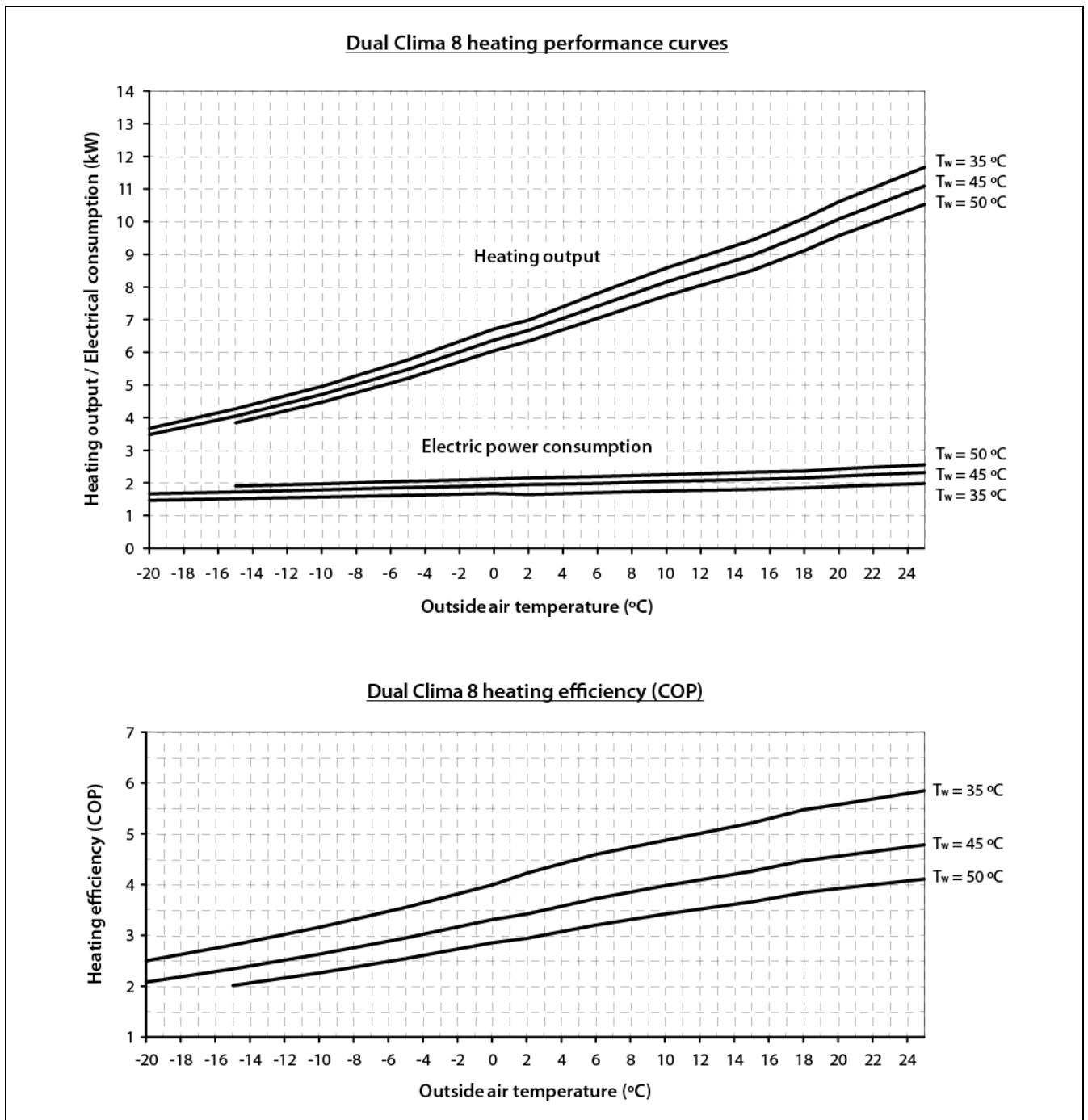

# DUAL CLIMA

## Dual Clima 11

Dual Clima 11 heating performance curves

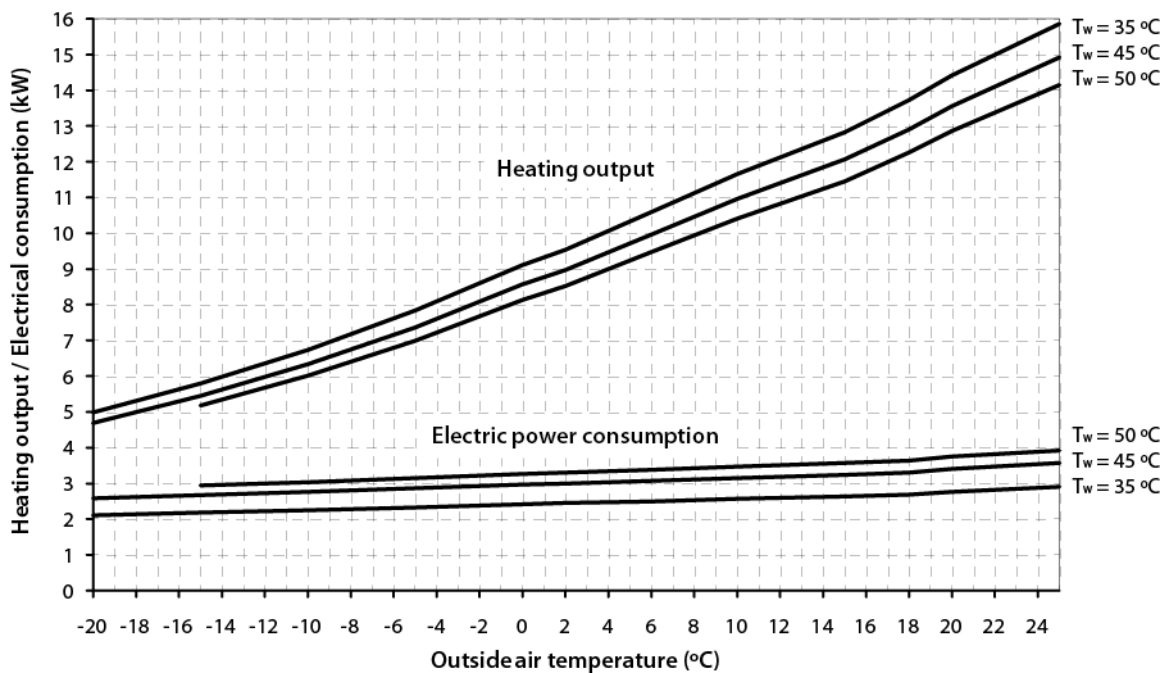

Dual Clima 11 heating efficiency (COP)

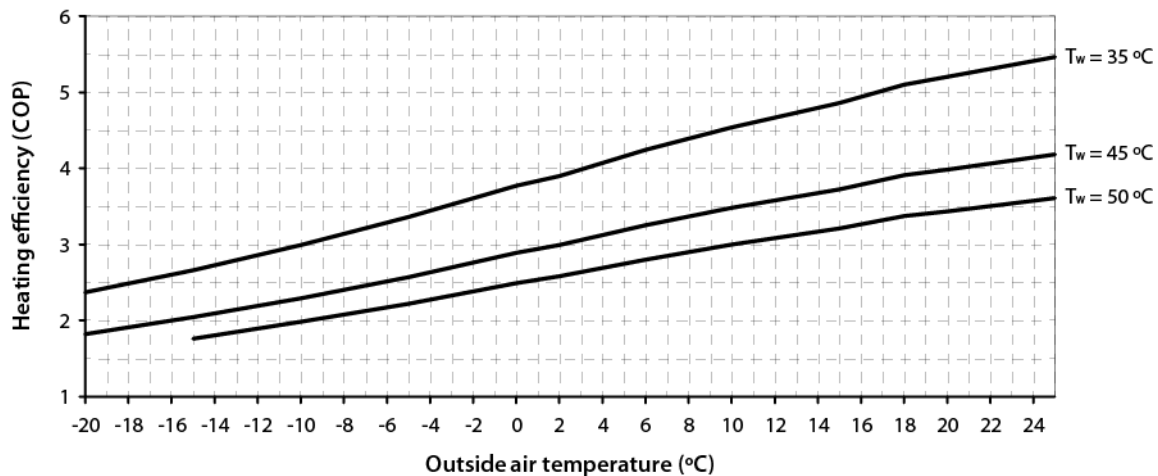

**Dual Clima 16**

**Dual Clima 16 heating performance curves**

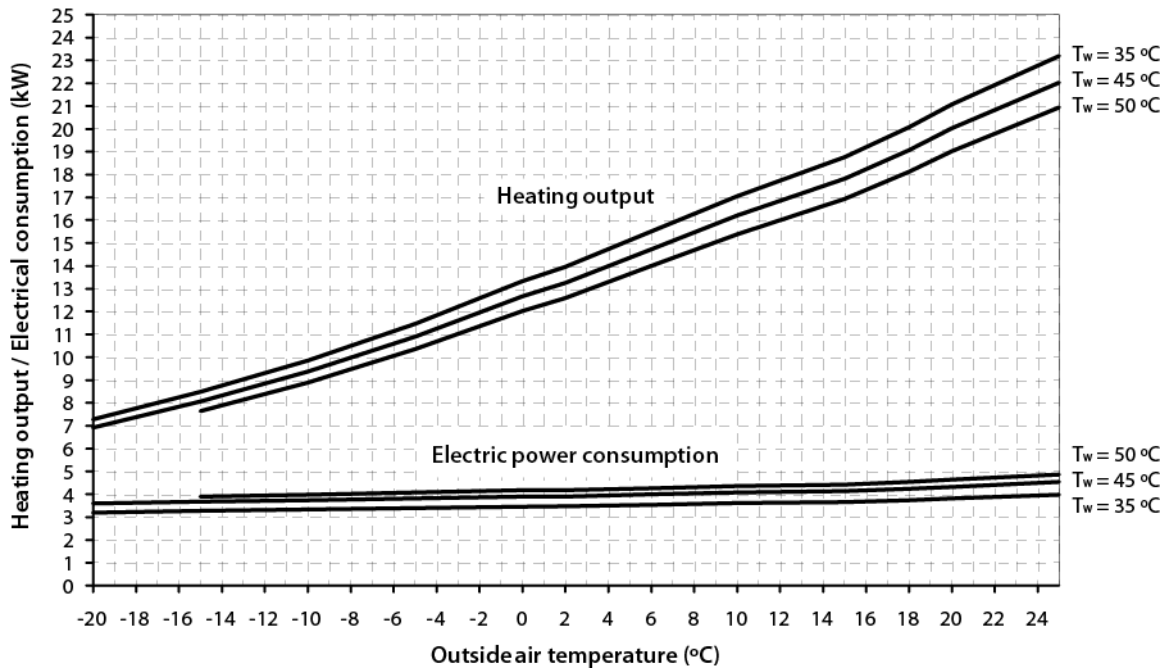

**Dual Clima 16 heating efficiency (COP)**

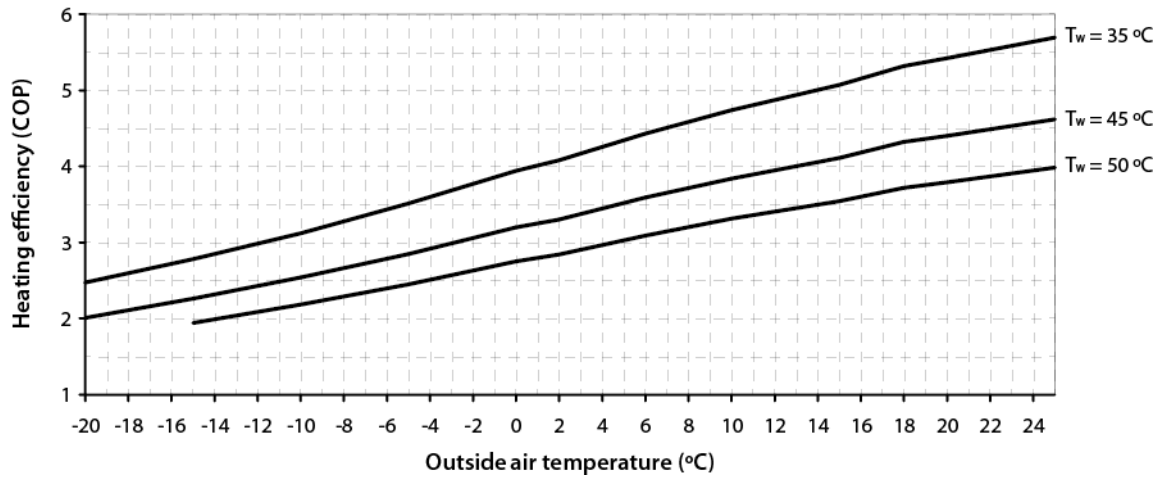

# DUAL CLIMA

## 17 TECHNICAL CHARACTERISTICS

MODEL		DUAL CLIMA 8	DUAL CLIMA 11	DUAL CLIMA 16
Heating nominal capacity	kW	7.80	10.60	15.50
Cooling nominal capacity	kW	8.40	9.45	15.70
Heating nominal consumption	kW	1.70	2.50	3.44
Cooling nominal consumption	kW	2.25	3.05	4.40
Heating nominal intensity	A	7.39	11.20	15.60
Cooling nominal intensity	A	9.78	13.40	20.00
COP (Air +7°C, Water 35°C)	-	4.59	4.24	4.50
Maximum consumption	kW	2.88	3.45	5.75
Maximum intensity	A	12.5	15.0	25.0
Electrical supply	-	230 V~ / 50 Hz		
Max. service pressure: (water circuit)	MPa (bar)	0.3 (3)		
Max. water temperature	°C	60		
Nominal water flow	m <sup>3</sup> /h	1.50	1.85	2.80
Max. working pressure: (coolant circuit)	MPa	4.2		
Coolant	-	R410A		
Coolant amount	Kg	2.30	3.30	3.90
Protection degree	-	IPX4		
Sound level	dB(A)	46	49	52
Dimensions: (Height/Width/Depth)	mm	700/1115/425	960/1115/425	1270/1115/425
Net weight	Kg	90	125	150

**18 DIAGRAMS AND MEASUREMENTS**

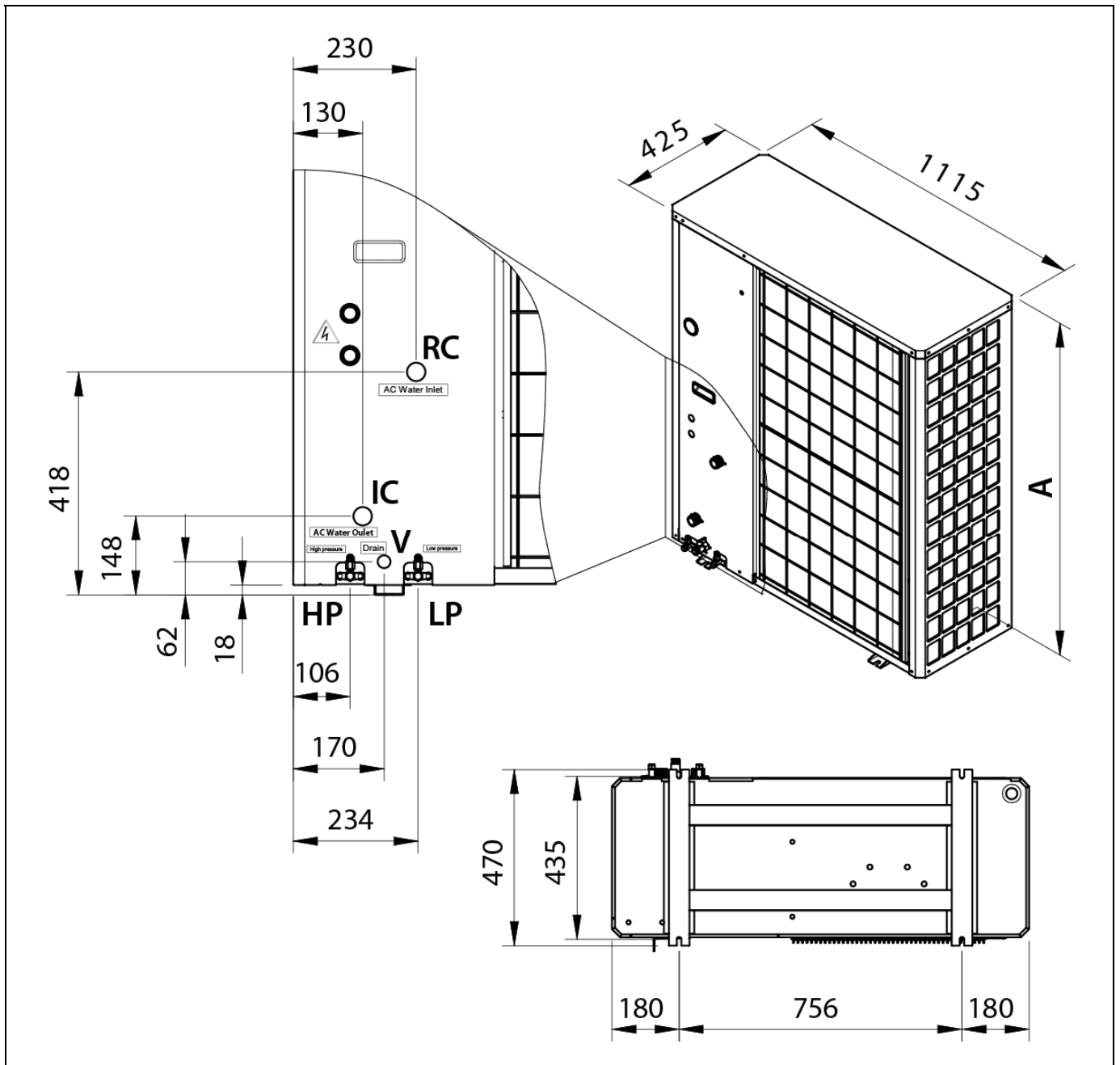

	DUAL CLIMA 8	DUAL CLIMA 11	DUAL CLIMA 16
Total height (mm)	700	960	1270

**IC:** Flow Heating/Cooling

**RC:** Return Heating/Cooling.

**V:** Solar circuit drainage.

**HP:** Gas circuit high-pressure outlet.

**LP:** Gas circuit low-pressure outlet.

### 19.1 Nomenclature

#### Refrigerant circuit components:

**MC:** Compressor motor.

**RL:** Reactance.

**MV:** Fan motor.

**CV:** Fan capacitor.

**EEV:** Electronic expansion valve.

**V4V:** 4-way valve.

**VB:** Bypass valve.

**TD:** Discharge thermostat.

**PH:** High-pressure switch.

**PL:** Low-pressure switch.

**AN1:** Discharge temperature sensor.

**AN2:** Evaporator temperature sensor.

**AN3:** Outdoor temperature sensor.

**AN6:** Suction temperature sensor.

**CN11:** Pressure switch.

#### Water circuit power supply and components:

**L:** Phase.

**N:** Neutral.

**F:** Fuse.

**R:** Relay.

**Q:** Flow meter.

**SW1:** DIP-Switch 1.

**MAN:** Main board.

#### Component connection terminal:

**E1:** DHW backup resistor.

**E2:** Heating backup resistor.

**C4:** Circulator pump of the heat pump.

**C5:** Circulator pump of the installation.

**C6:** Backup circulator pump.

**G1:** Heating/DHW 3-way valve.

**G3:** Heat/Cold 3-way valve.

#### Input connection terminal:

**IN1:** DHW temperature sensor.

**IN2:** Return temperature sensor.

**IN3:** Flow temperature sensor.

**IN4:** Solar temperature sensor.

**IN6:** Room Sensor option resistor.

**IN7:** Air thermostat.

**IN8:** Tube temperature sensor.

**19.2 Dual Clima 8**

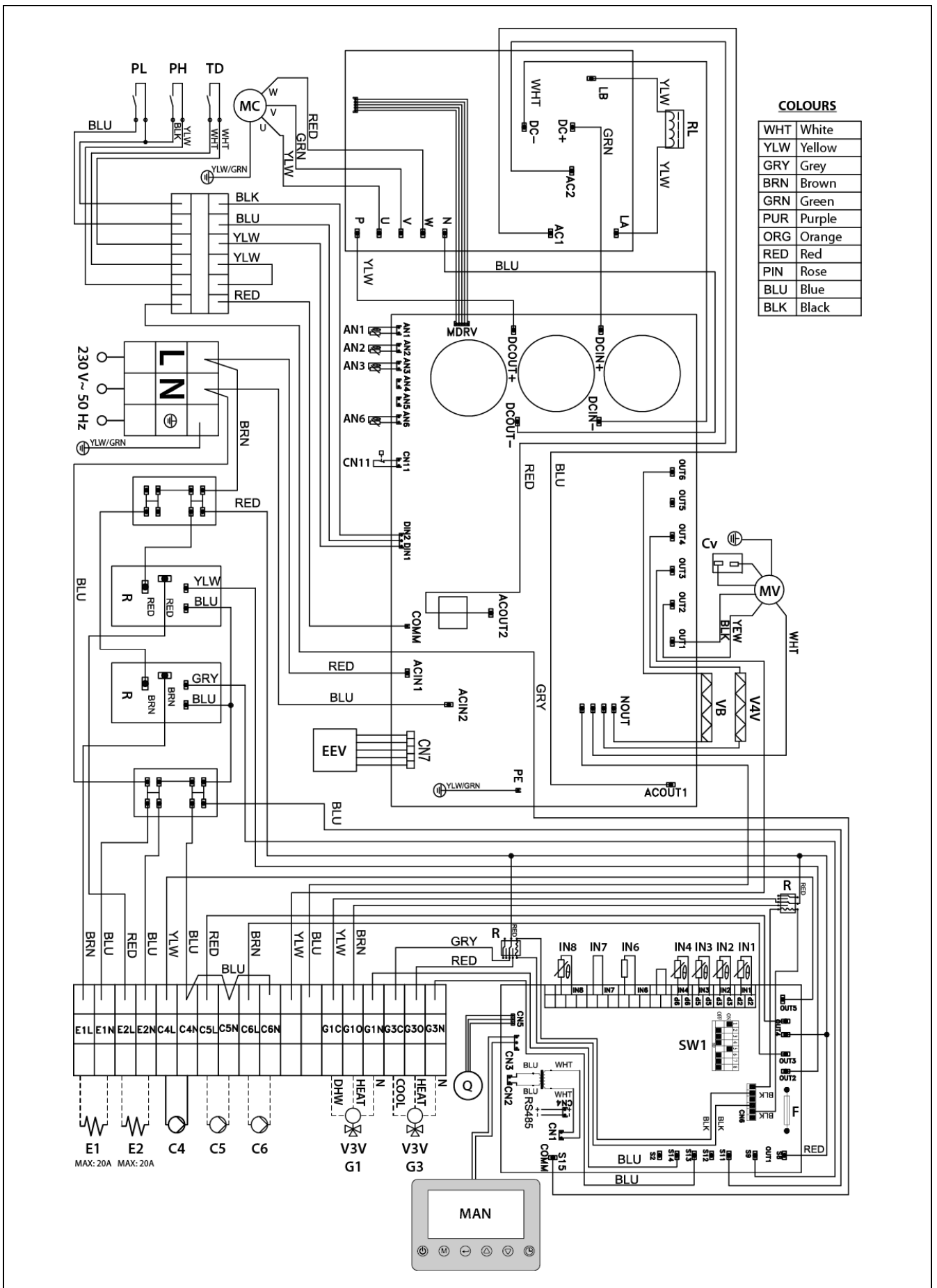

# DUAL CLIMA

## 19.3 Dual Clima 11

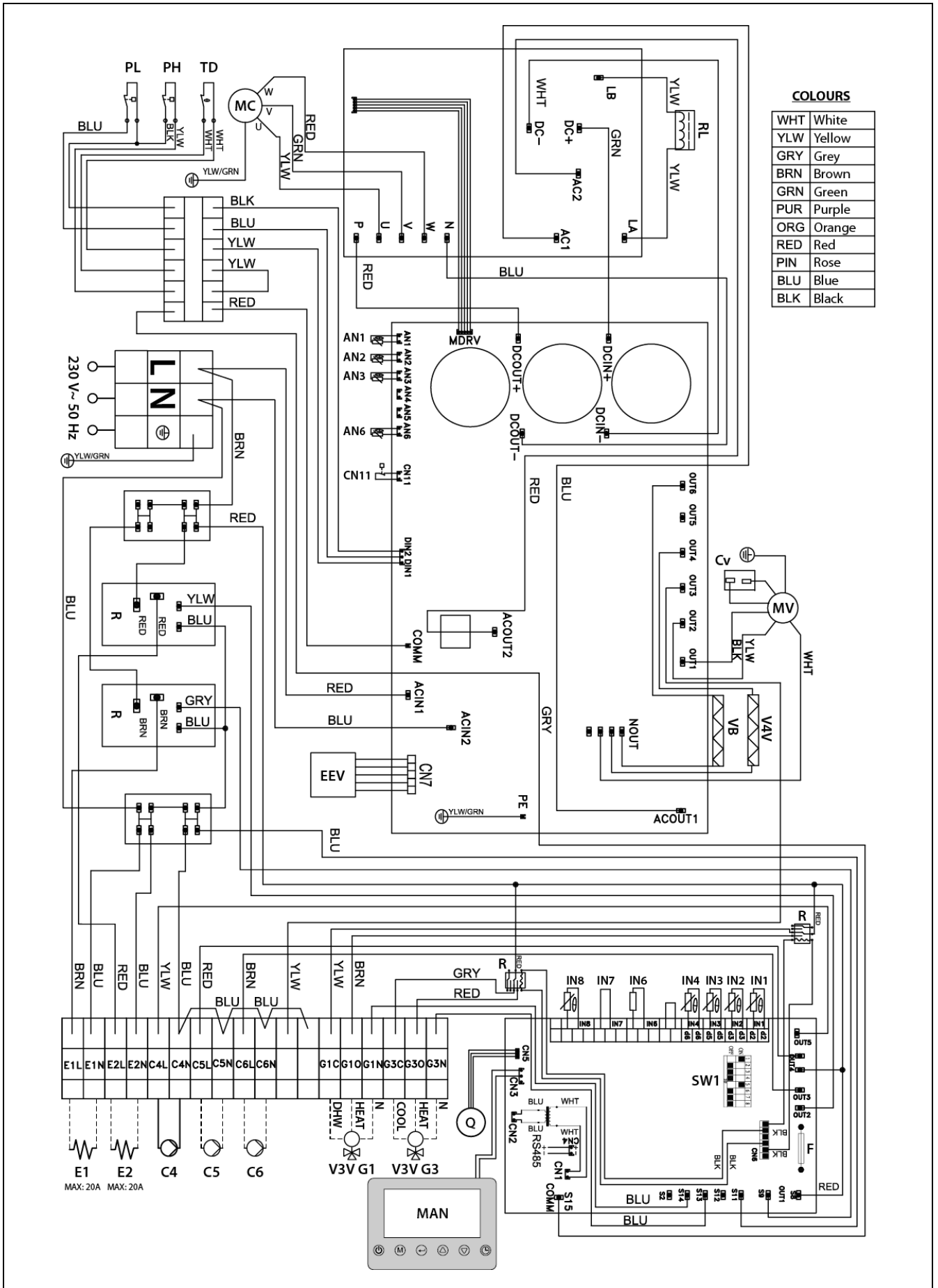



**19.4 Dual Clima 16**

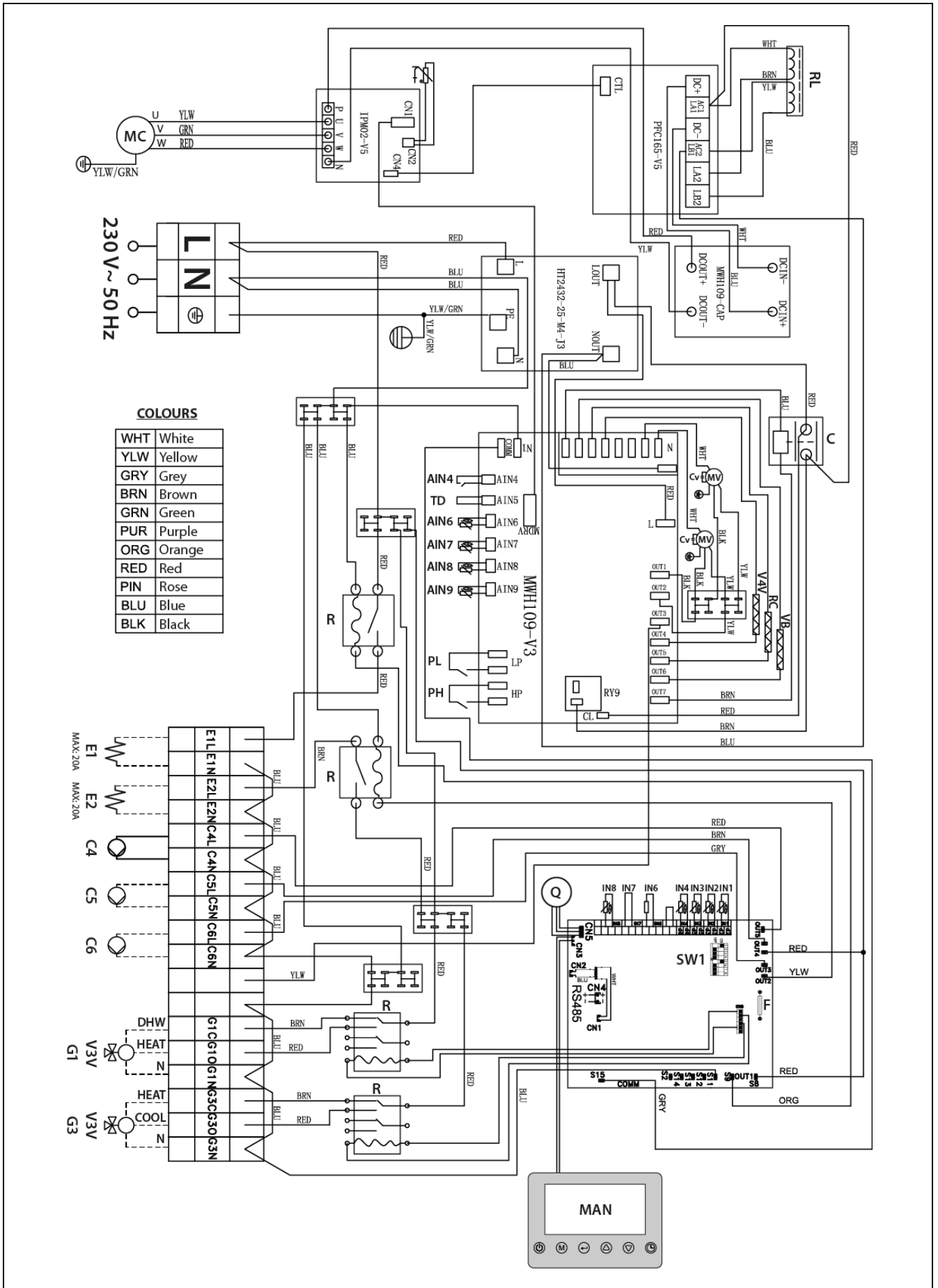

# DUAL CLIMA

## 20 ALARM CODES

The **DUAL CLIMA** heat pump has an electronic controller that performs continuous self-testing to detect any pump malfunctioning. When the controller detects malfunctioning, this is indicated by an alarm code and the ✕ service symbol on the main board display. The table below shows a list of the alarm codes that may appear:

Code	Alarm	Description
<b>E1</b>	Excess temperature in the compressor gas discharge.	The compressor safety thermostat is enabled. Contact the nearest official Technical Assistance Service.
<b>E2</b>	Outdoor temperature sensor.	Open circuit or short circuit in the outdoor temperature sensor. Contact your nearest official Technical Assistance Service to have it replaced.
<b>E3</b>	Tube or return air temperature sensor.	Open circuit or short circuit in the temperature sensor or suction sensor. Contact your nearest official Technical Assistance Service to have it replaced.
<b>E4</b>	Return temperature sensor.	Open circuit or short circuit in the return temperature sensor. Contact your nearest official Technical Assistance Service to have it replaced.
<b>E5</b>	Flow temperature sensor.	Open circuit or short circuit in the flow temperature sensor. Contact your nearest official Technical Assistance Service to have it replaced.
<b>E6</b>	DHW temperature sensor.	Open circuit or short circuit in the flow temperature sensor. Contact your nearest official Technical Assistance Service to have it replaced.
<b>E7</b>	Solar temperature sensor.	Open circuit or short circuit in the solar temperature sensor. Contact your nearest official Technical Assistance Service to have it replaced.
<b>E8</b>	Excess temperature in the external heat exchanger.	The safety thermostat of the external heat exchanger has been activated. Contact your nearest official Technical Assistance Service.
<b>E9</b>	Antifreeze function in Heating/Cooling mode.	The antifreeze function in heating/cooling mode has been activated twice in 90 minutes. Disconnect and reconnect the power supply of the heat pump. If the alarm is triggered persistently repeatedly, contact the nearest official Technical Assistance Service.
<b>EA</b>	Antifreeze function in DHW mode.	The antifreeze function in DHW mode has been activated twice in 60 minutes. Disconnect and reconnect the power supply of the heat pump. If the alarm is triggered persistently repeatedly, contact the nearest official Technical Assistance Service.
<b>EB</b>	Internal coolant tube temperature sensor.	Open circuit or short circuit in the temperature sensor. Contact your nearest official Technical Assistance Service to have it replaced.
<b>EC</b>	Water inlet temperature sensor:	Open circuit or short circuit in the temperature sensor. Contact your nearest official Technical Assistance Service to have it replaced.
<b>ED</b>	Water outlet temperature sensor:	Open circuit or short circuit in the temperature sensor. Contact your nearest official Technical Assistance Service to have it replaced.

Code	Alarm	Description
<b>EE</b>	Antifreeze protection of the water circuit.	The antifreeze function has been activated. Disconnect and reconnect the power supply of the heat pump. If the alarm is triggered persistently repeatedly, contact the nearest official Technical Assistance Service.
<b>EF</b>	Insufficient water flow.	The water flow meter of the machine detects a lower water flow than that allowed for each moment of the heat pump (see " <i>Hydraulic Installation</i> "). Disconnect and reconnect the power supply of the heat pump. If the alarm is triggered persistently repeatedly, contact the nearest official Technical Assistance Service.
<b>EG</b>	Room sensor.	Open circuit or short circuit in the room sensor. Contact your nearest official Technical Assistance Service to have it replaced.
<b>F1</b>	Voltage protection.	The voltage of the power supply is too high, too low, or unstable. The heat pump will recover when the voltage is within the value range allowed by the heat pump (165-265 V AC)
<b>F2</b>	IPM module.	Error in the IPM module or incorrect cable connection. Disconnect and reconnect the power supply of the heat pump. If the alarm is triggered persistently repeatedly, contact the nearest official Technical Assistance Service.
<b>F3</b>	Abnormal stop of the compressor.	The compressor stops abnormally. Contact your nearest official Technical Assistance Service.
<b>F4</b>	Radiator sensor of the external IPM module.	Open circuit or short circuit in the temperature sensor. Contact your nearest official Technical Assistance Service to have it replaced.
<b>F5</b>	Current sensor of the outdoor unit.	Failure of the internal ammeter of the machine or the power cable does not cross it. Contact your nearest official Technical Assistance Service to have it repaired.
<b>F6</b>	IPM module or module control.	The communication is not good or fails in the IPM Module. Contact your nearest official Technical Assistance Service to have it repaired.
<b>F7</b>	The compressor does not start.	The compressor cannot start properly. Contact your nearest official Technical Assistance Service.
<b>F8</b>	Overcurrent in the outdoor unit.	The electric current of the compressor is too high. Contact your nearest official Technical Assistance Service.
<b>F9</b>	Water outlet temperature sensor of the compressor:	Open circuit or short circuit in the temperature sensor. Contact your nearest official Technical Assistance Service to have it replaced.
<b>FA</b>	Overheating of the external module.	IPM module temperature too high or compressor current too high. Contact your nearest official Technical Assistance Service.
<b>FB/E8</b>	Overheating of the external heat exchanger.	The external heat exchange is not sufficient. Contact the nearest Official Technical Assistance Service to carry out a general review of the heat pump.
<b>P1</b>	High pressure protection.	The high-pressure switch has been activated. Disconnect and reconnect the power supply of the heat pump. If the alarm is triggered persistently repeatedly, contact the nearest official Technical Assistance Service.

## DUAL CLIMA

Code	Alarm	Description
P2	Low pressure protection.	The low-pressure switch has been activated. Disconnect and reconnect the power supply of the heat pump. If the alarm is triggered persistently repeatedly, contact the nearest official Technical Assistance Service.
P3	Disconnect and reconnect the power supply of the heat pump.	The discharge thermostat has been activated. Disconnect and reconnect the power supply of the heat pump. If the alarm is triggered persistently repeatedly, contact the nearest official Technical Assistance Service.
P4	Excess voltage.	The overvoltage sensor has been activated. Contact your nearest official Technical Assistance Service.
P5	Insufficient water flow.	The water flow meter of the machine detects a lower water flow than that allowed for each moment of the heat pump (see " <i>Hydraulic Installation</i> "). Disconnect and reconnect the power supply of the heat pump. If the alarm is triggered persistently repeatedly, contact the nearest official Technical Assistance Service.
P7	Lack of phase.	Error in the power supply. Contact your nearest official Technical Assistance Service to have it repaired.
P8	Incorrect phase.	Error in the power supply. Contact your nearest official Technical Assistance Service to have it repaired.
P9	Communication failure.	Open communication cable or power inverter board error. Contact your nearest official Technical Assistance Service to have it replaced.

**NOTE:** It will be very useful for the technical assistance service if you can inform them of the alarm code that has appeared on call-out.







# DOMUSA

## T E K N I K

**POSTAL ADDRESS**

PO box 95  
20730 AZPEITIA

Tel: (+34) 943 813 899

**FACTORY & OFFICES**

B° San Esteban s/n  
20737 RÉGIL (Guipúzcoa)

Fax: (+34) 943 815 666

**[www.domusateknik.com](http://www.domusateknik.com)**

**DOMUSA TEKNIK** reserves the right to make modifications of any kind to its product characteristics without prior notice.



CDOC001732

04/18